

# Plan of Organization

Updated as of June 30, 2022

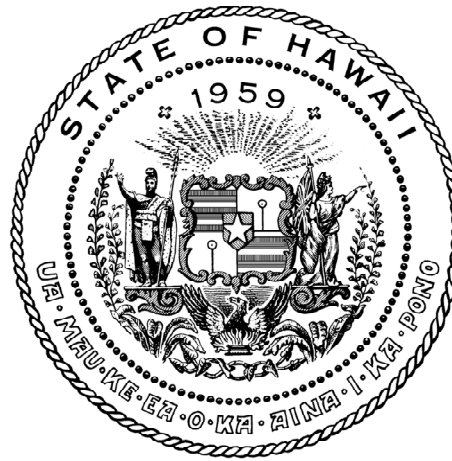

Department of Education  
State of Hawaii

Office of Talent Management/Management Support Services Section ~ Department of Education ~ State of Hawaii ~ Revised June 30, 2022

## FOREWORD

The Department of Education (DOE) *Plan of Organization* documents the official organization of state and complex area offices of the department, as approved by the Superintendent of Education pursuant to Section 302A-1111, Hawaii Revised Statutes. The *Plan of Organization* describes the organizational structure, supervisory relationships among established positions, and the functions of each state and complex area office in the department. This edition supersedes all previous editions of the DOE *Plan of Organization*.

Any change to the organizational structure, supervisory relationships among established positions, or functional responsibilities described herein must be submitted for approval. Organizational change requests may be initiated at any time by the designated head of the office affected. Offices contemplating an organizational change should inform the Office of Talent Management (OTM), Management Support Services Section.

The *Plan of Organization* shall be updated annually to reflect routine changes in the titles, numbers, and salary ranges of established positions. OTM will coordinate the annual update. OTM shall maintain the *Plan of Organization* and distribute the annual update and any intervening approved organizational changes to all holders of the *Plan*.

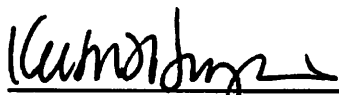

---

Keith T. Hayashi  
Superintendent of Education

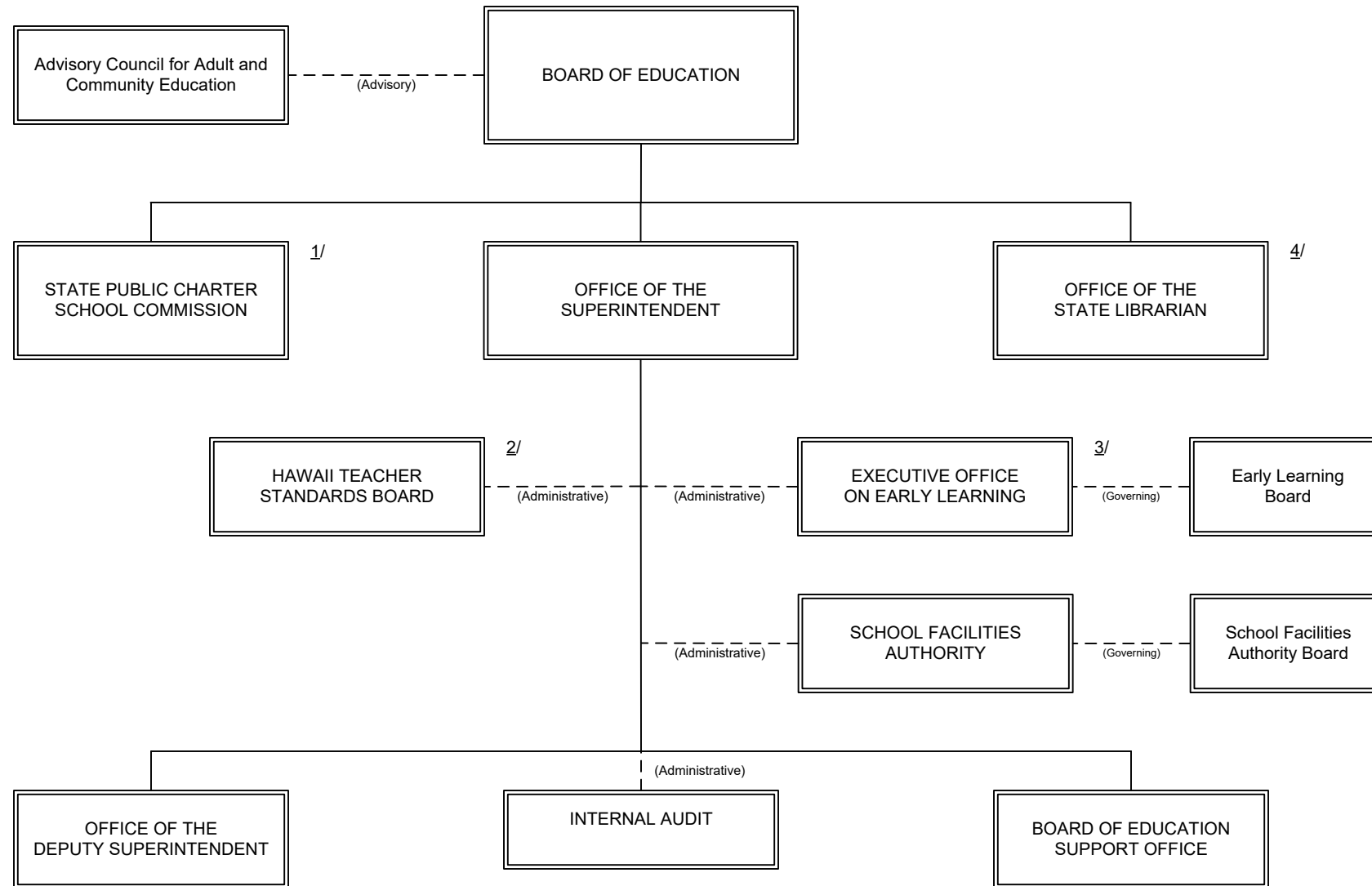

<sup>1/</sup> The State Public Charter School Commission organization is published separately.

<sup>2/</sup> The Executive Director is appointed by the BOE.

<sup>3/</sup> The Executive Director is appointed by the Early Learning Board.

<sup>4/</sup> The public library system organization is published separately by the State Librarian.

## COMPLEX AREA SCHOOLS

### HONOLULU DISTRICT

#### Farrington / Kaiser / Kalani Complex Area

##### Farrington Complex

Farrington High  
Dole Middle  
Kalakaua Middle  
Fern Elementary  
Kaewai Elementary  
Kalihi Elementary  
Kalihi-Kai Elementary  
Kalihi-Uka Elementary  
Kalihi-Waena Elementary  
Kapalama Elementary  
Linapuni Elementary  
Puuhale Elementary

##### Kaiser Complex

Kaiser High  
Niu Valley Middle  
Aina Haina Elementary  
Hahaione Elementary  
Kamiloiki Elementary  
Koko Head Elementary

##### Kalani Complex

Kalani High  
Kaimuki Middle  
Kahala Elementary  
Liholiho Elementary  
Waikiki Elementary  
Wilson Elementary  
Hawaii School for the Deaf & the Blind

##### Community School for Adults

Farrington Campus

#### Kaimuki / McKinley / Roosevelt Complex Area

##### Kaimuki Complex

Kaimuki High  
Jarrett Middle  
Washington Middle  
Ala Wai Elementary  
Aliiolani Elementary  
Hokulani Elementary  
Jefferson Elementary  
Kuhio Elementary  
Lunalilo Elementary  
Palolo Elementary

##### McKinley Complex

McKinley High  
Kaahumanu Elementary  
Kaiulani Elementary  
Kauluwela Elementary  
Lanakila Elementary  
Likelike Elementary  
Princess Ruth Ke'elikōlani Middle  
Royal Elementary

##### Roosevelt Complex

Roosevelt High  
Kawanānakoā Middle  
Stevenson Middle  
Lincoln Elementary  
Maemae Elementary  
Manoa Elementary  
Noelani Elementary  
Nuuanu Elementary  
Pauoa Elementary  
Anuenue Elementary & High

##### Community School for Adults

McKinley Community School  
(Main Center)

### CENTRAL DISTRICT

#### Aiea / Moanalua / Radford Complex Area

##### Aiea Complex

Aiea High  
Aiea Intermediate  
Aiea Elementary  
Pearl Ridge Elementary  
Scott Elementary  
Waimalu Elementary  
Webbing Elementary

##### Moanalua Complex

Moanalua High  
Moanalua Middle  
Moanalua Elementary  
Red Hill Elementary  
Salt Lake Elementary  
Shafter Elementary

##### Radford Complex

Radford High  
Aliamanu Middle  
Aliamanu Elementary  
Hickam Elementary  
Makalapa Elementary  
Mokulele Elementary  
Nimitz Elementary  
Pearl Harbor Elementary  
Pearl Harbor Kai Elementary

##### Community School for Adults

Moanalua Campus

#### Leilehua / Mililani / Waialua Complex Area

##### Leilehua Complex

Leilehua High  
Wahiawa Middle  
Wheeler Middle  
Hale Kula Elementary  
Helemano Elementary  
Iliahi Elementary  
Kaala Elementary  
Solomon Elementary  
Wahiawa Elementary  
Wheeler Elementary

##### Mililani Complex

Mililani High  
Mililani Middle  
Kipapa Elementary  
Mililani 'Ike Elementary  
Mililani Mauka Elementary  
Mililani Uka Elementary  
Mililani Waena Elementary

##### Waialua Complex

Waialua High & Intermediate  
Haleiwa Elementary  
Waialua Elementary

##### Community School for Adults

Wahiawa Campus

## COMPLEX AREA SCHOOLS

### LEEWARD DISTRICT

#### Campbell / Kapolei Complex Area

##### Campbell Complex

Campbell High  
 Ilima Intermediate  
 Ewa Elementary  
 Ewa Beach Elementary  
 Ewa Makai Middle  
 Holomua Elementary  
 Iroquois Point Elementary  
 Kaimiloa Elementary  
 Keoneula Elementary  
 Pohakea Elementary

##### Kapolei Complex

Kapolei High  
 Kapolei Middle  
 Barbers Point Elementary  
 Hookele Elementary  
 Kapolei Elementary  
 Makakilo Elementary  
 Mauka Lani Elementary  
 Honouliuli Middle

##### Community School for Adults

Kapolei Campus

#### Nanakuli / Waianae Complex Area

##### Nanakuli Complex

Nanakuli High & Intermediate  
 Nanaikapono Elementary  
 Nanakuli Elementary

##### Waianae Complex

Waianae High  
 Waianae Intermediate  
 Leihoku Elementary  
 Maili Elementary  
 Makaha Elementary  
 Waianae Elementary

##### Community School for Adults

Waianae Campus

#### Pearl City / Waipahu Complex Area

##### Pearl City Complex

Pearl City High  
 Highlands Intermediate  
 Kanoelani Elementary  
 Lehua Elementary  
 Manana Elementary  
 Momilani Elementary  
 Palisades Elementary  
 Pearl City Elementary  
 Pearl City Highlands Elementary  
 Waiau Elementary

##### Waipahu Complex

Waipahu High  
 Waipahu Intermediate  
 August Ahrens Elementary  
 Honowai Elementary  
 Kaleiopuu Elementary  
 Waikele Elementary  
 Waipahu Elementary

##### Community School for Adults

Waipahu Community School  
 (Main Center)

### WINDWARD DISTRICT

#### Castle / Kahuku Complex Area

##### Castle Complex

Castle High  
 King Intermediate  
 Ahuimanu Elementary  
 Heeia Elementary  
 Kahaluu Elementary  
 Kaneohe Elementary  
 Kapunahala Elementary  
 Parker Elementary  
 Puohala Elementary  
 Waiahole Elementary

##### Kahuku Complex

Kahuku High & Intermediate  
 Hauula Elementary  
 Kaaawa Elementary  
 Kahuku Elementary  
 Laie Elementary  
 Sunset Beach Elementary

#### Kailua / Kalaheo Complex Area

##### Kailua Complex

Kailua High  
 Enchanted Lake Elementary  
 Kaelepulu Elementary  
 Keolu Elementary  
 Maunawili Elementary  
 Pope Elementary  
 Waimanalo Elem & Intermediate  
 Olomana School

##### Kalaheo Complex

Kalaheo High  
 Kailua Intermediate  
 Aikahi Elementary  
 Kailua Elementary  
 Kainalu Elementary  
 Mokapu Elementary

##### Community School for Adults

Windward Campus

## COMPLEX AREA SCHOOLS

### HAWAII DISTRICT

**Hilo / Laupahoehoe / Waiakea Complex Area**

Hilo Complex

Hilo High  
 Hilo Intermediate  
 Kalaniana'ole Elem & Intermediate  
 De Silva Elementary  
 Haaheo Elementary  
 Hilo Union Elementary  
 Kapiolani Elementary  
 Kaumana Elementary  
 Keaukaha Elementary

Waiakea Complex

Waiakea High  
 Waiakea Intermediate  
 Waiakea Elementary  
 Waiakeawaena Elementary

Community School for Adults

Waipahu Community School  
 Hilo Campus

**Ka'u / Keaau / Pahoa Complex Area**

Ka'u Complex

Ka'u High & Pahala Elementary  
 Naalehu Elementary

Keaau Complex

Keaau High  
 Keaau Middle  
 Keaau Elementary  
 Mountain View Elementary

Pahoa Complex

Pahoa High & Intermediate  
 Keonepoko Elementary  
 Pahoa Elementary

**Honokaa / Kealakehe / Kohala / Konawaena Complex Area**

Honokaa Complex

Honokaa High & Intermediate  
 Paauiolo Elementary & Intermediate  
 Honokaa Elementary  
 Waimea Elementary

Kealakehe Complex

Kealakehe High  
 Kealakehe Intermediate  
 Holualoa Elementary  
 Kealakehe Elementary  
 Waikoloa Elementary & Middle

Kohala Complex

Kohala High  
 Kohala Middle  
 Kohala Elementary

Konawaena Complex

Kahakai Elementary  
 Konawaena High  
 Konawaena Middle  
 Konawaena Elementary  
 Honaunau Elementary  
 Hookena Elementary  
 Ke Kula O Ehunuikaimalino High & Elementary

Community School for Adults

Waipahu Community School  
 Kona Campus

### MAUI DISTRICT

**Baldwin / Kekaulike / Maui Complex Area**

Baldwin Complex

Baldwin High  
 Iao Intermediate  
 Puu Kukui Elementary  
 Waihee Elementary  
 Wailuku Elementary

Kekaulike Complex

Kekaulike High  
 Kalama Intermediate  
 Haiku Elementary  
 Kula Elementary  
 Makawao Elementary  
 Paia Elementary  
 Pukalani Elementary

Maui Complex

Maui High  
 Lokelani Intermediate  
 Maui Waena Intermediate  
 Kahului Elementary

Kamalii Elementary  
 Kihei Elementary  
 Lihikai Elementary  
 Pomaikai Elementary

Community School for Adults

Maui Campus

**Hana / Lahaina / Lanai / Molokai Complex Area**

Hana Complex

Hana High & Elementary

Lahaina Complex

Lahainaluna High  
 Lahaina Intermediate  
 Kamehameha III Elementary  
 Nahienaena Elementary

Lanai Complex

Lanai High & Elementary

Molokai Complex

Molokai High  
 Molokai Middle  
 Kaunakakai Elementary  
 Kilohana Elementary  
 Maunaloa Elementary

## COMPLEX AREA SCHOOLS

### KAUAI DISTRICT

#### Kapaa / Kauai / Waimea Complex Area

##### Kapaa Complex

Kapaa High  
Kapaa Middle  
Hanalei Elementary  
Kapaa Elementary  
Kilauea Elementary

##### Kauai Complex

Kauai High  
Kamakahahei Middle  
Kaumualii Elementary  
Koloa Elementary  
Wilcox Elementary

##### Waimea Complex

Waimea High  
Waimea Canyon Middle  
Eleele Elementary  
Kalaheo Elementary  
Kekaha Elementary  
Niihau High & Elementary

##### Community School for Adults

Kauai Campus

STATE OF HAWAII  
DEPARTMENT OF EDUCATION  
BOARD OF EDUCATION  
ORGANIZATION CHART

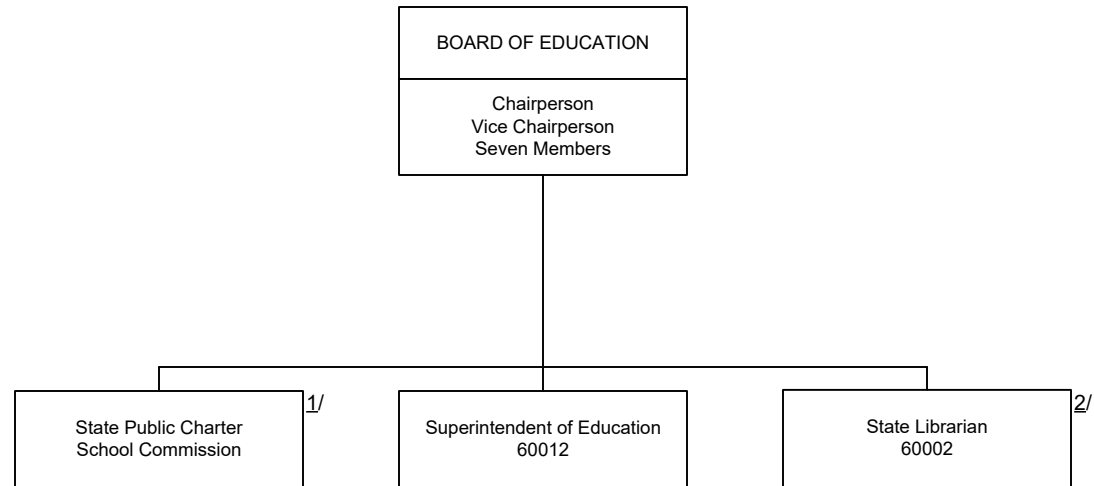

<sup>1/</sup> The State Public Charter School Commission organization is published separately.

<sup>2/</sup> The public library system organization is published separately by the State Librarian.



STATE OF HAWAII  
DEPARTMENT OF EDUCATION  
ORGANIZATION CHART

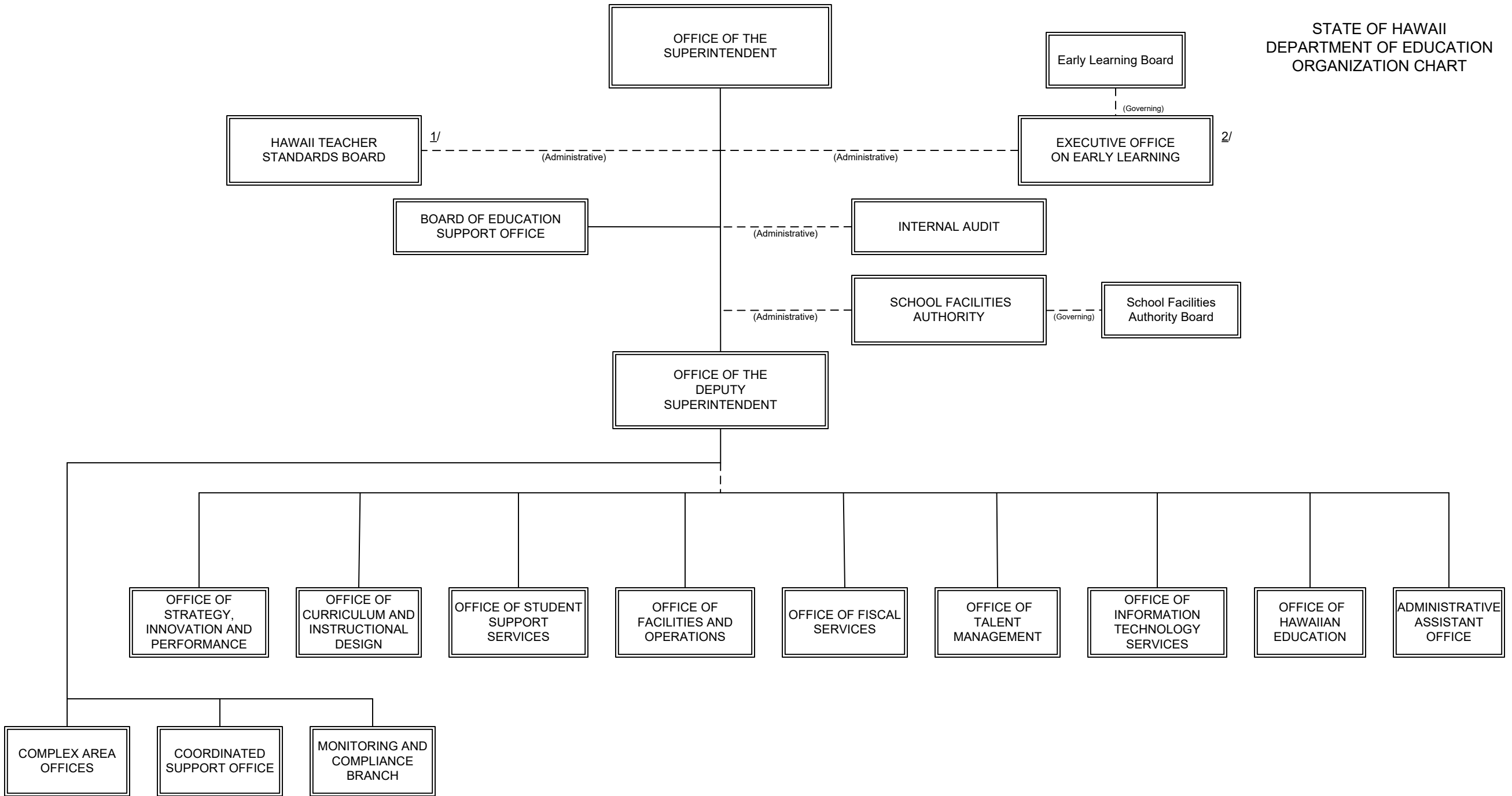

1/ The Executive Director is appointed by the BOE.

2/ The Executive Director is appointed by the Early Learning Board.

STATE OF HAWAII  
DEPARTMENT OF EDUCATION  
OFFICE OF THE SUPERINTENDENT  
ORGANIZATION CHART

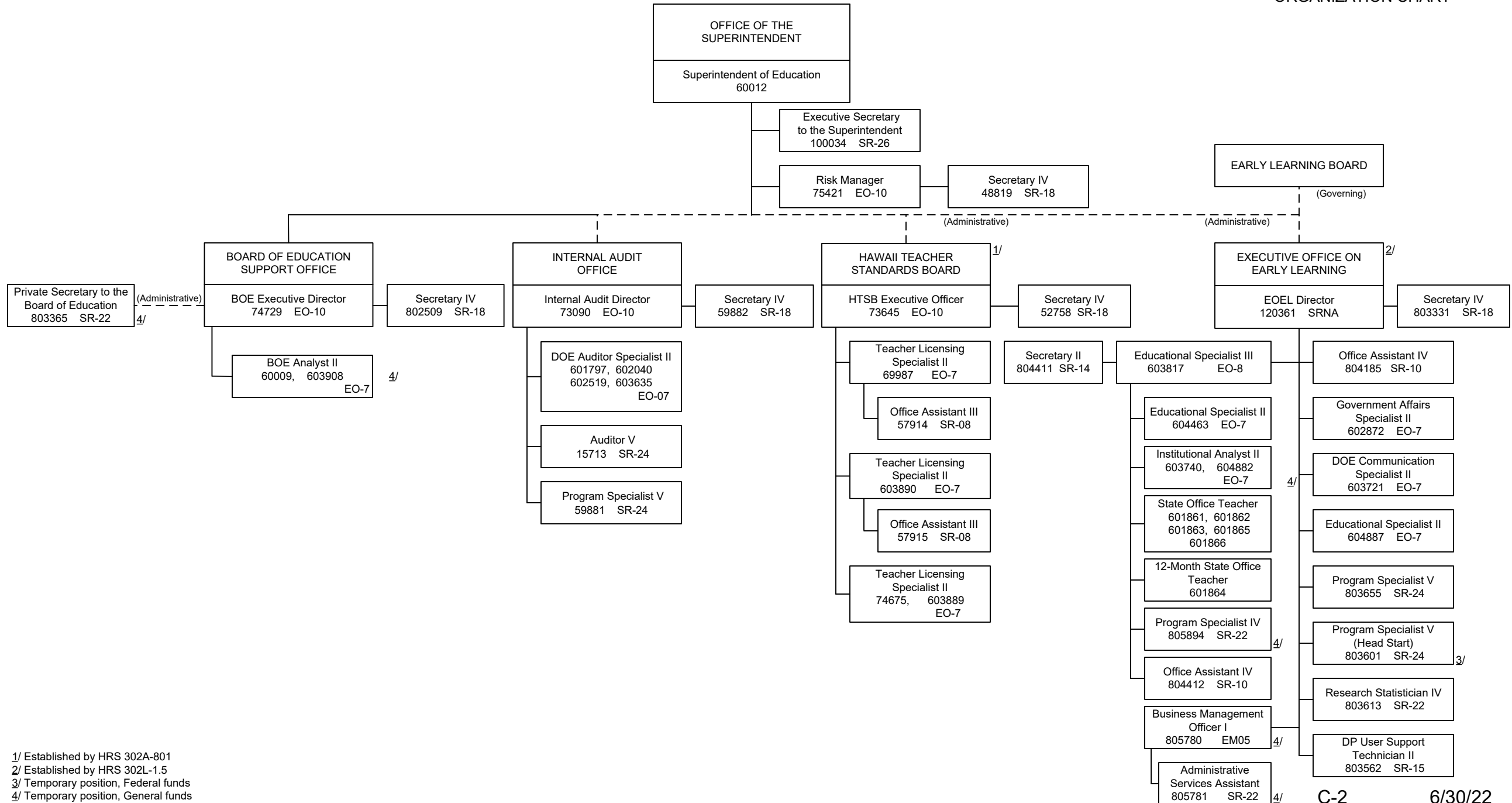

1/ Established by HRS 302A-801  
2/ Established by HRS 302L-1.5  
3/ Temporary position, Federal funds  
4/ Temporary position, General funds

STATE OF HAWAII  
DEPARTMENT OF EDUCATION  
OFFICE OF THE SUPERINTENDENT  
ORGANIZATION CHART

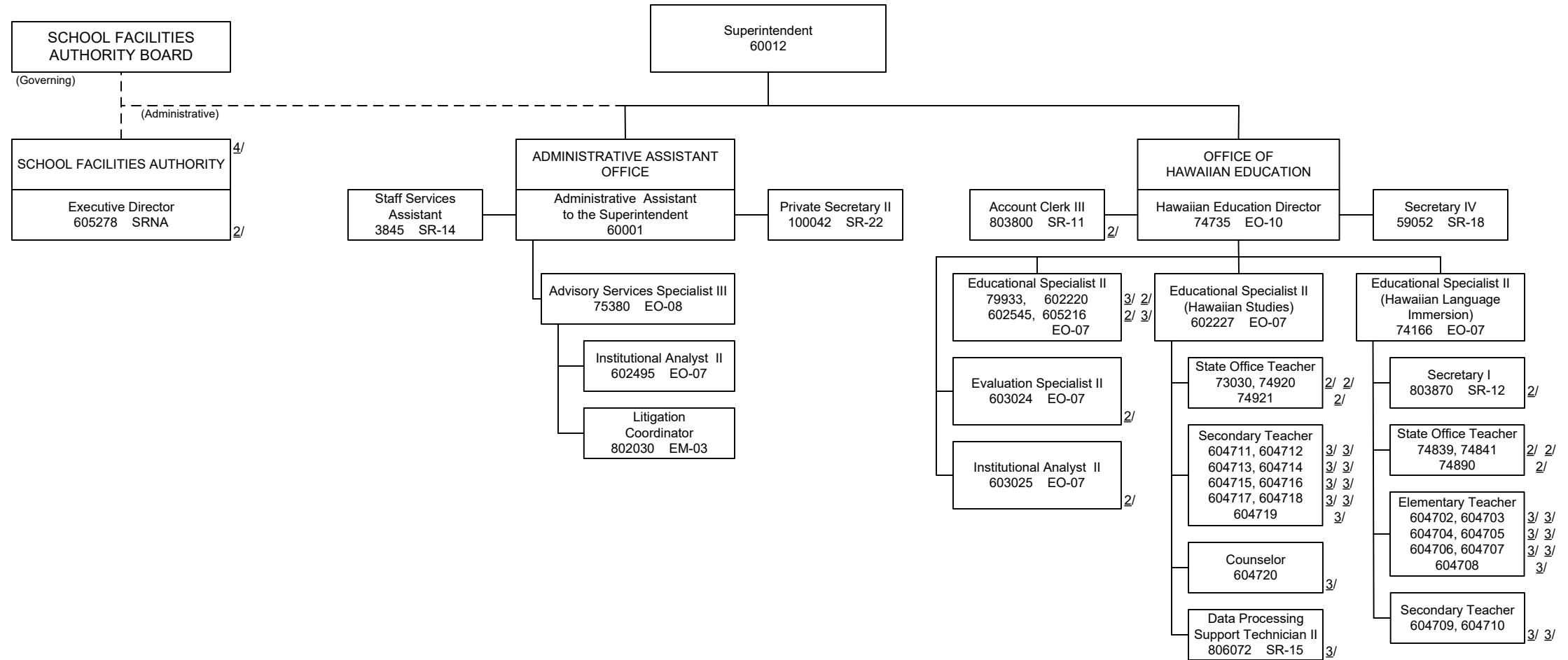

1/ Temporary position, Federal funds  
2/ Temporary position, General funds  
3/ Temporary position, ESSER funds  
4/ Established by HRS 302A-1702

STATE OF HAWAII  
DEPARTMENT OF EDUCATION  
OFFICE OF THE SUPERINTENDENT  
OFFICE OF STRATEGY,  
INNOVATION AND PERFORMANCE  
ORGANIZATION CHART

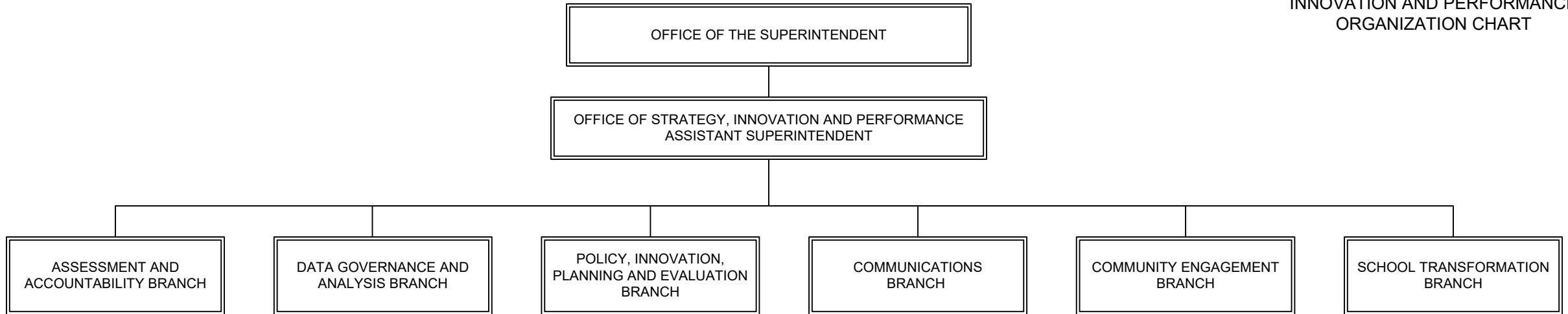

STATE OF HAWAII  
 DEPARTMENT OF EDUCATION  
 OFFICE OF THE SUPERINTENDENT  
 OFFICE OF STRATEGY,  
 INNOVATION AND PERFORMANCE  
 ORGANIZATION CHART

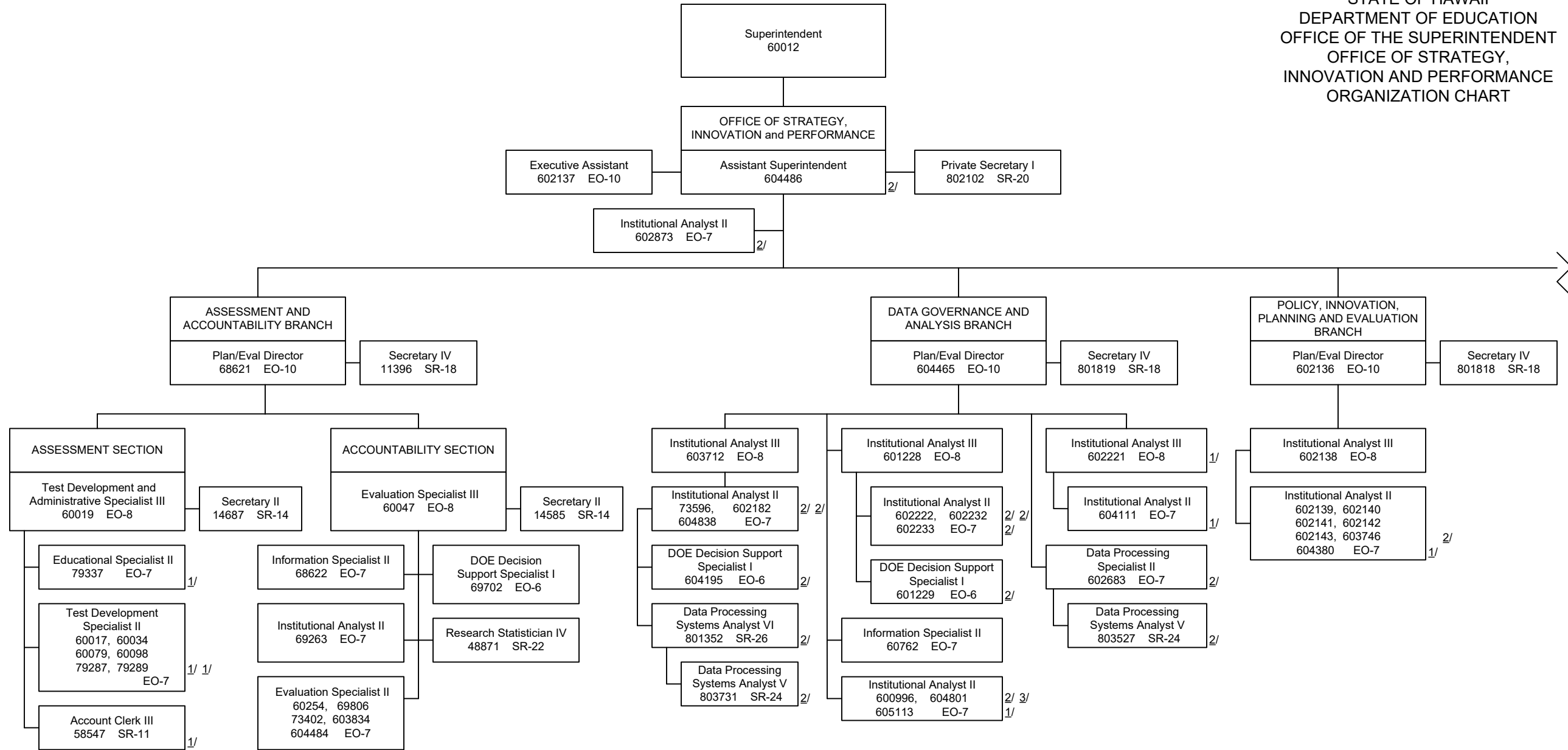

1/ Temporary position, Federal funds  
 2/ Temporary position, General funds  
 3/ Temporary position, ESSER funds

STATE OF HAWAII  
 DEPARTMENT OF EDUCATION  
 OFFICE OF THE SUPERINTENDENT  
 OFFICE OF STRATEGY,  
 INNOVATION AND PERFORMANCE  
 ORGANIZATION CHART

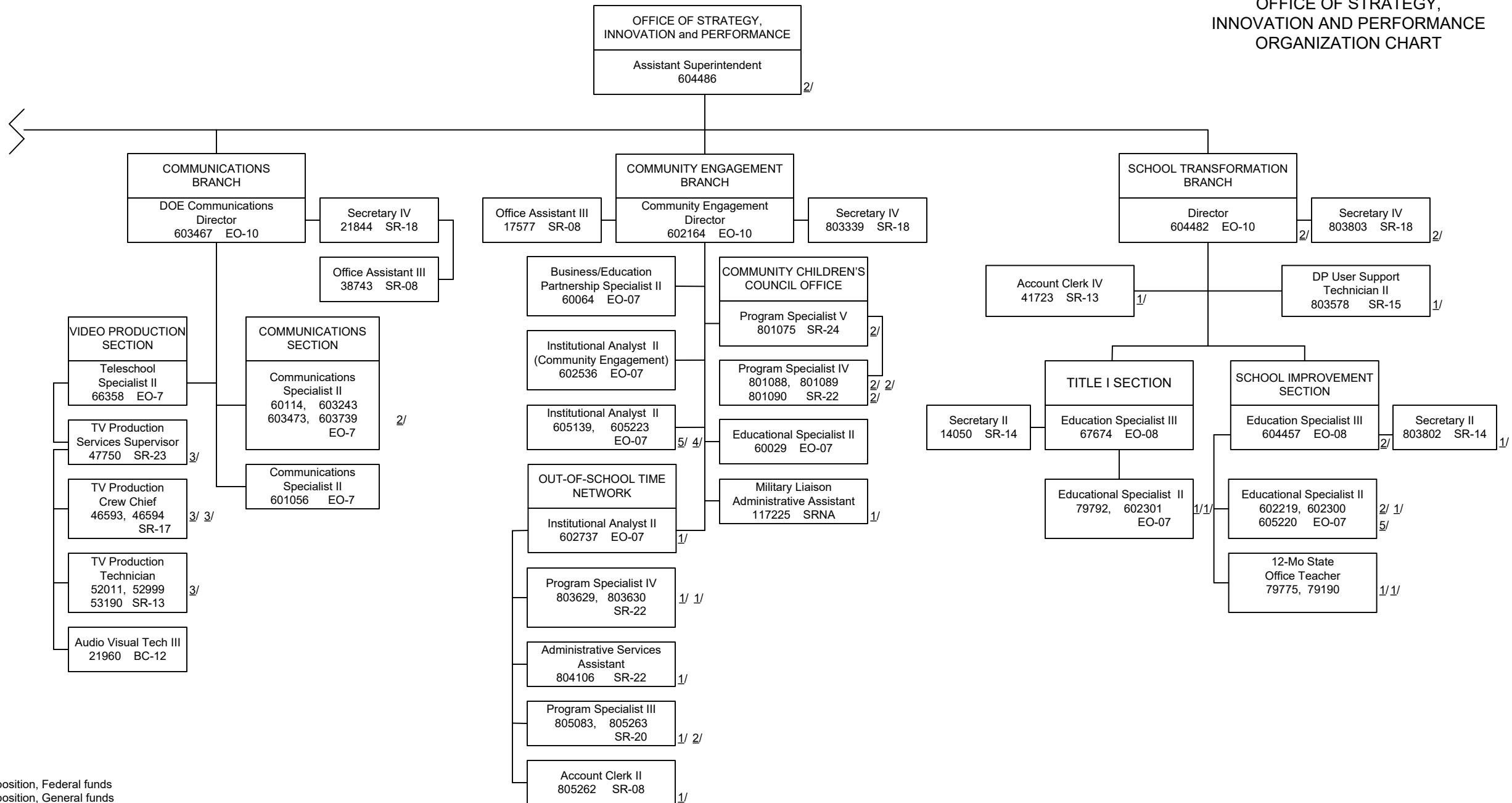

1/ Temporary position, Federal funds  
 2/ Temporary position, General funds  
 3/ Temporary position, Trust funds  
 4/ Temporary position, Revolving funds  
 5/ Temporary position, ESSER funds

STATE OF HAWAII  
DEPARTMENT OF EDUCATION  
OFFICE OF THE SUPERINTENDENT  
OFFICE OF CURRICULUM & INSTRUCTIONAL DESIGN  
ORGANIZATION CHART

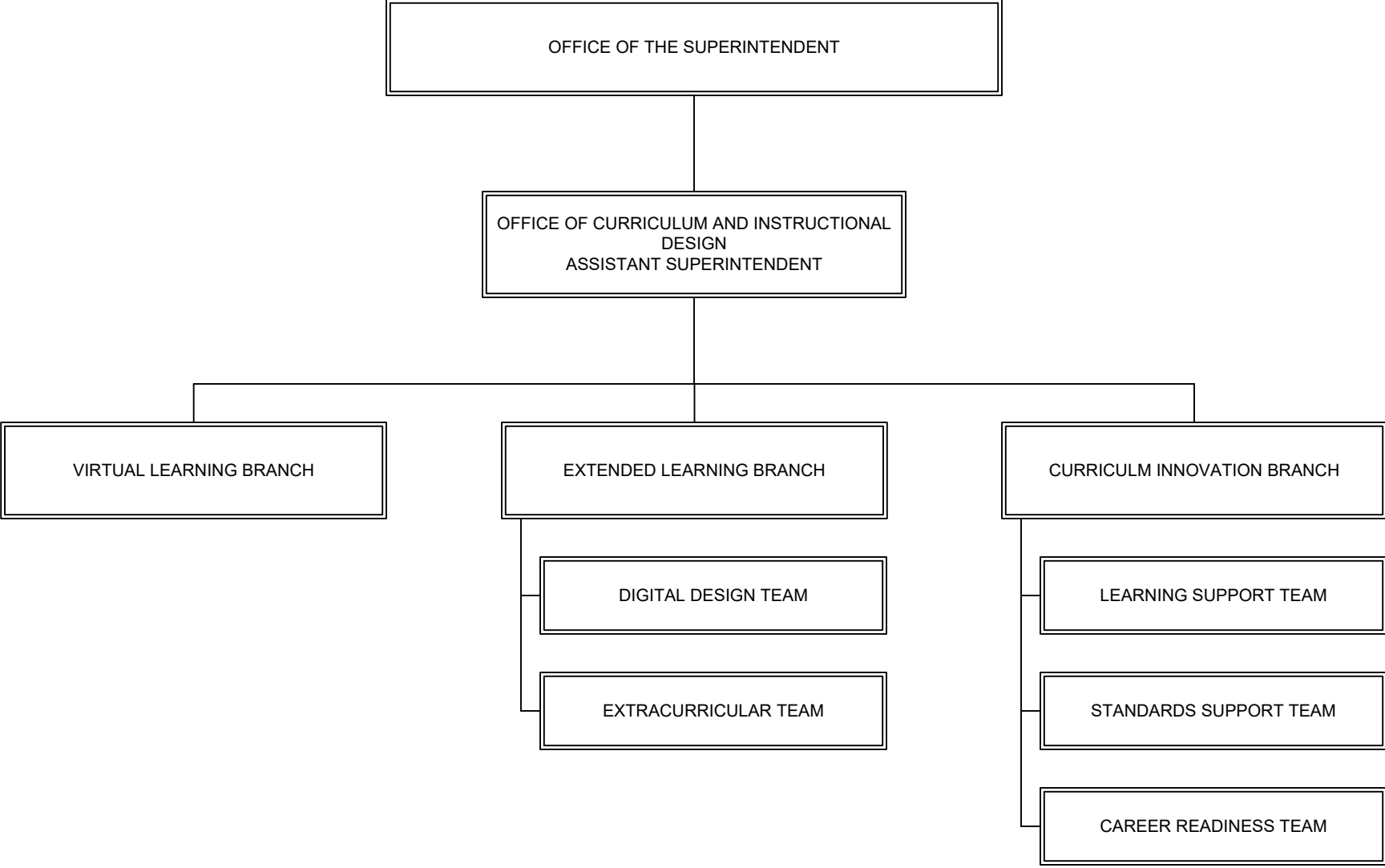

STATE OF HAWAII  
 DEPARTMENT OF EDUCATION  
 OFFICE OF THE SUPERINTENDENT  
 OFFICE OF CURRICULUM & INSTRUCTIONAL DESIGN  
 ORGANIZATION CHART

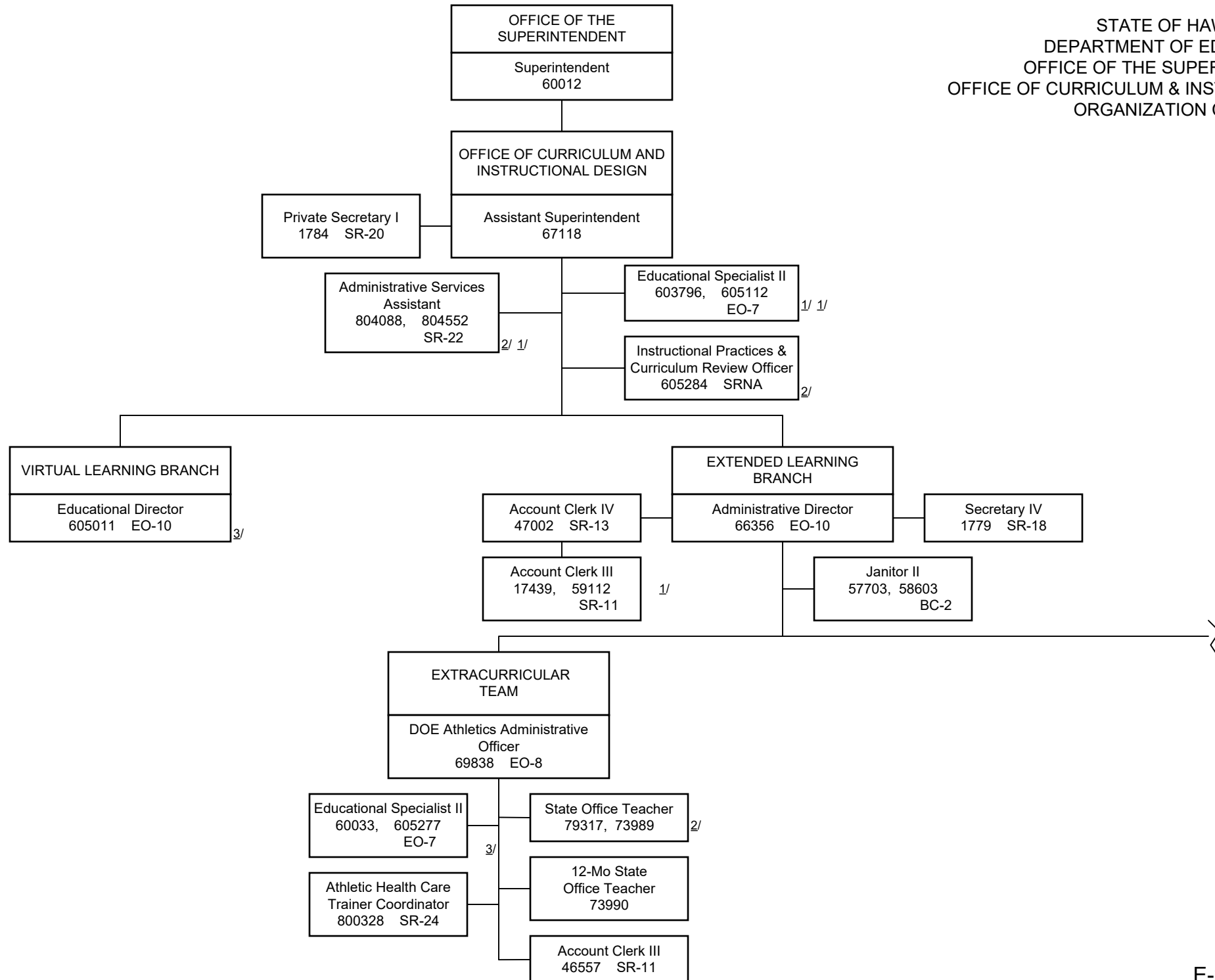

1/ Temporary position, Federal funds  
 2/ Temporary position, General funds  
 3/ Temporary position, ESSER funds



STATE OF HAWAII  
 DEPARTMENT OF EDUCATION  
 OFFICE OF THE SUPERINTENDENT  
 OFFICE OF CURRICULUM & INSTRUCTIONAL DESIGN  
 ORGANIZATION CHART

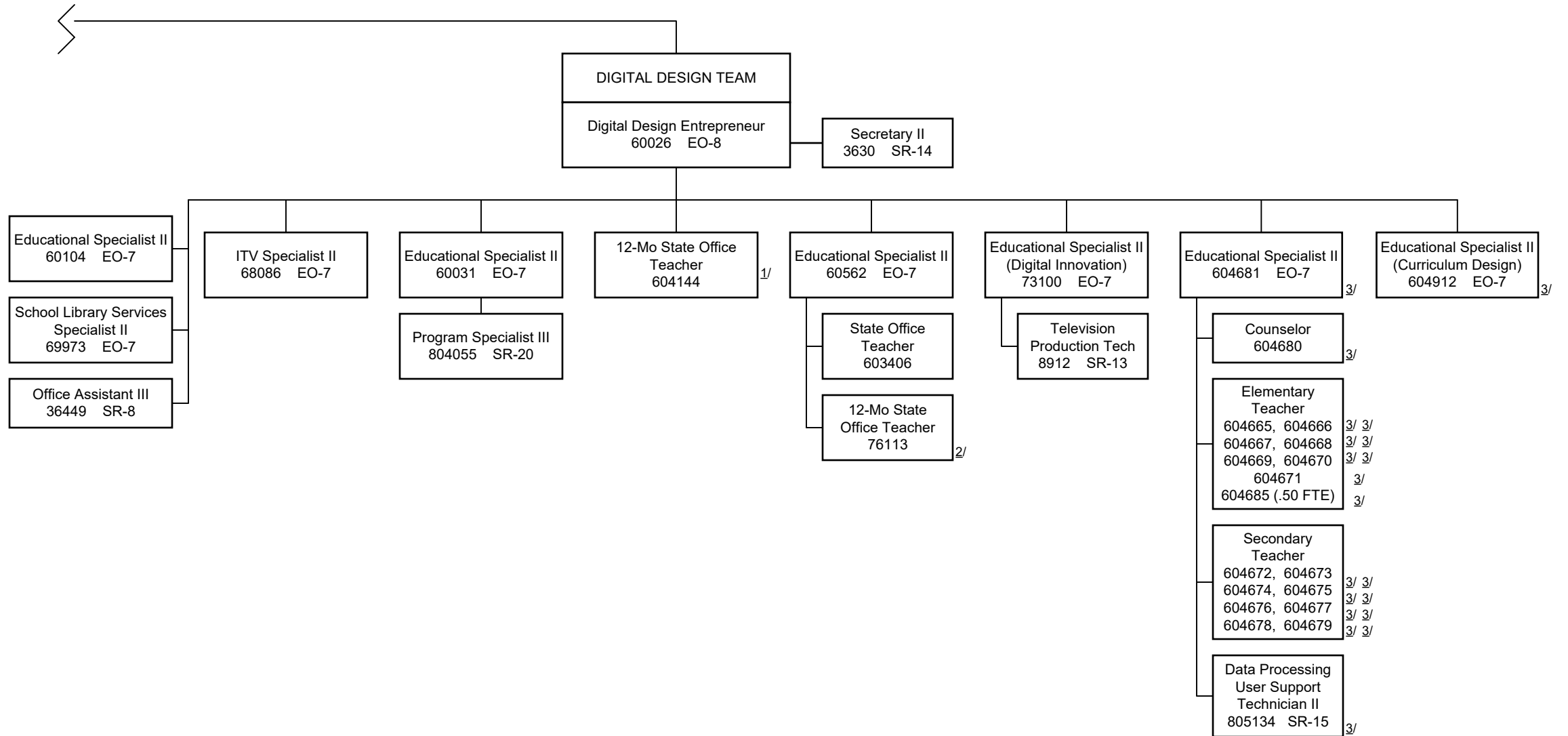

1/ Temporary position, Federal funds  
 2/ Temporary position, General funds  
 3/ Temporary position, ESSER funds

STATE OF HAWAII  
 DEPARTMENT OF EDUCATION  
 OFFICE OF THE SUPERINTENDENT  
 OFFICE OF CURRICULUM & INSTRUCTIONAL DESIGN  
 ORGANIZATION CHART

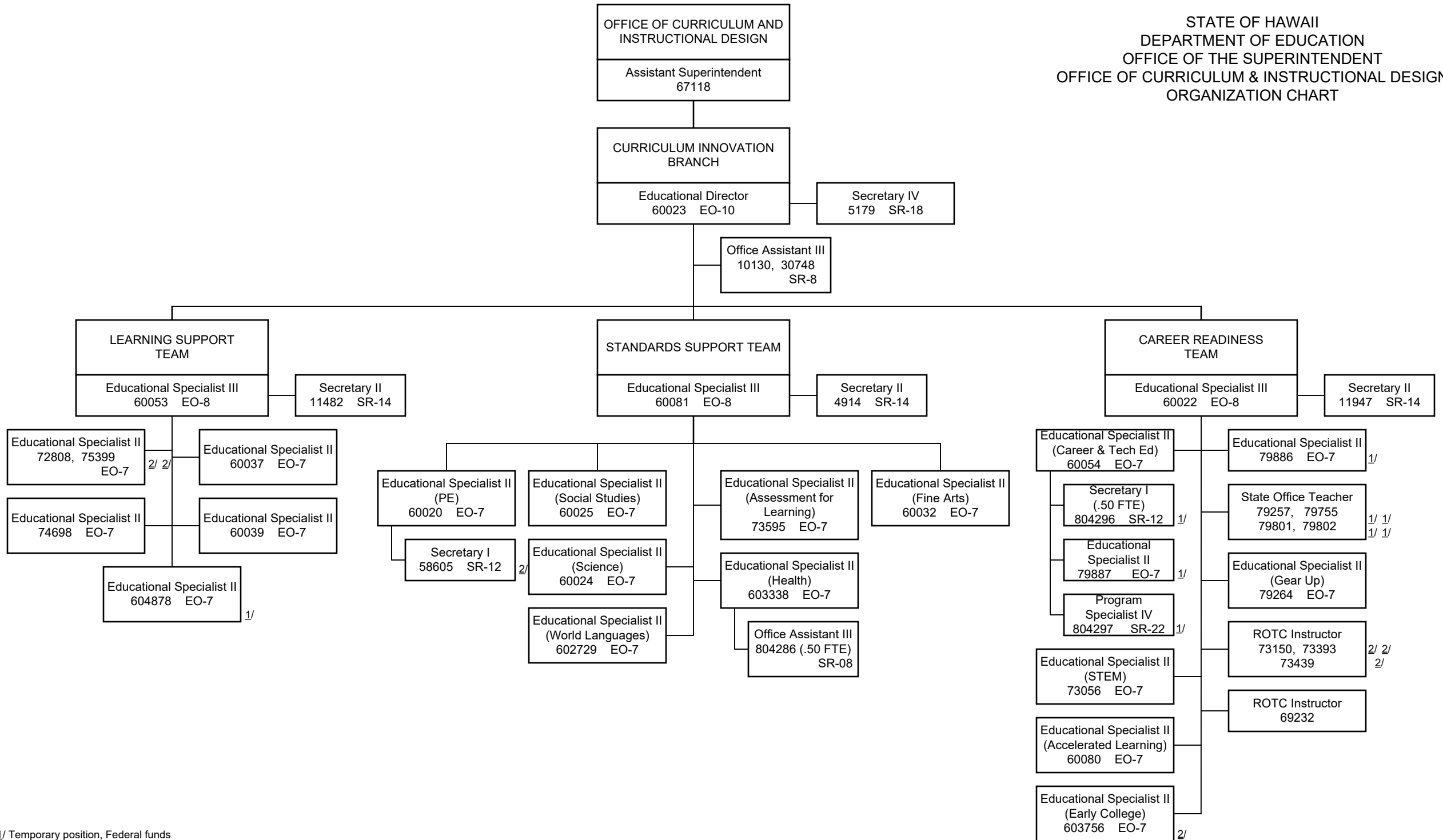

1/ Temporary position, Federal funds  
 2/ Temporary position, General funds

STATE OF HAWAII  
DEPARTMENT OF EDUCATION  
OFFICE OF THE SUPERINTENDENT  
OFFICE OF STUDENT SUPPORT SERVICES  
ORGANIZATION CHART

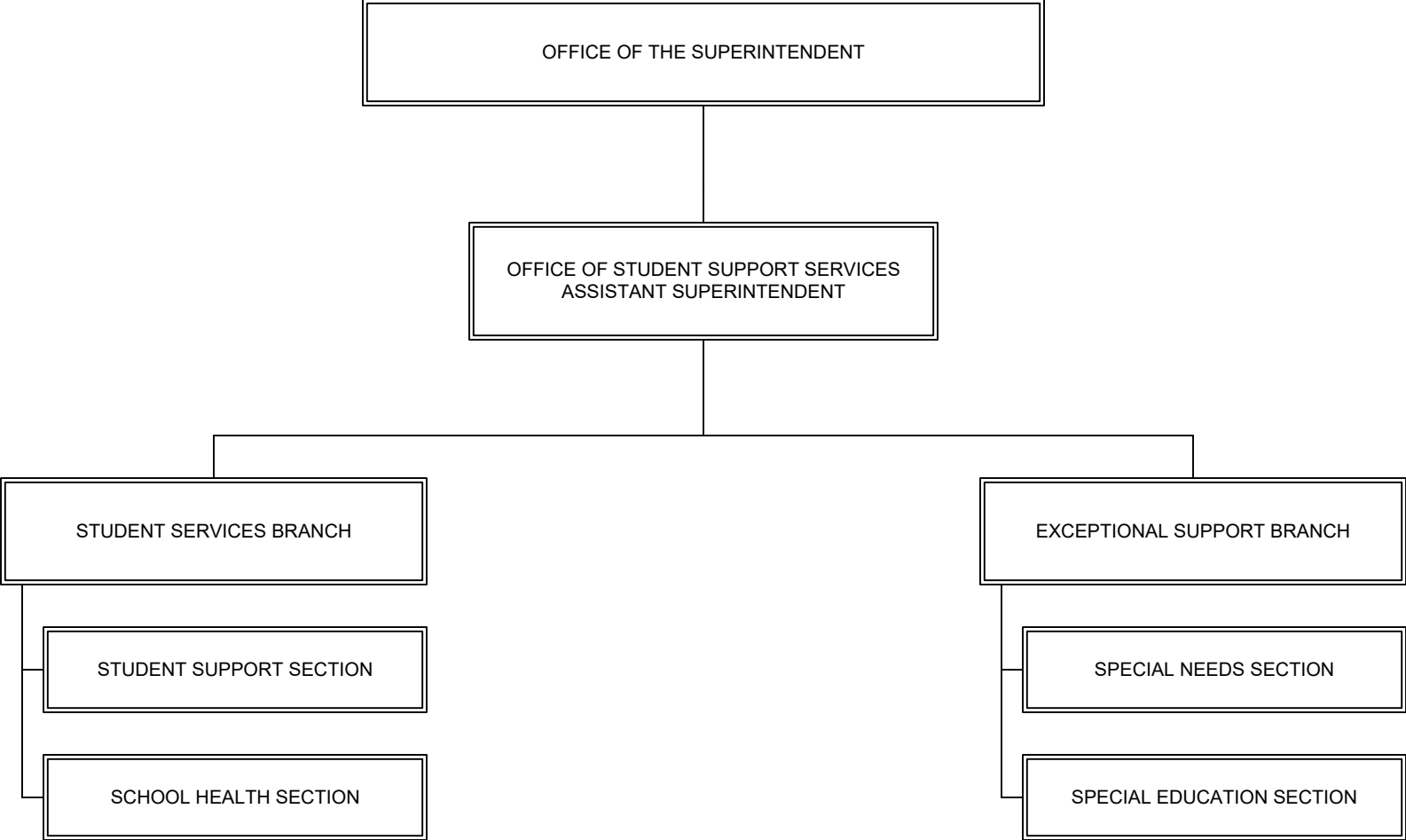

STATE OF HAWAII  
DEPARTMENT OF EDUCATION  
OFFICE OF THE SUPERINTENDENT  
OFFICE OF STUDENT SUPPORT SERVICES  
ORGANIZATION CHART

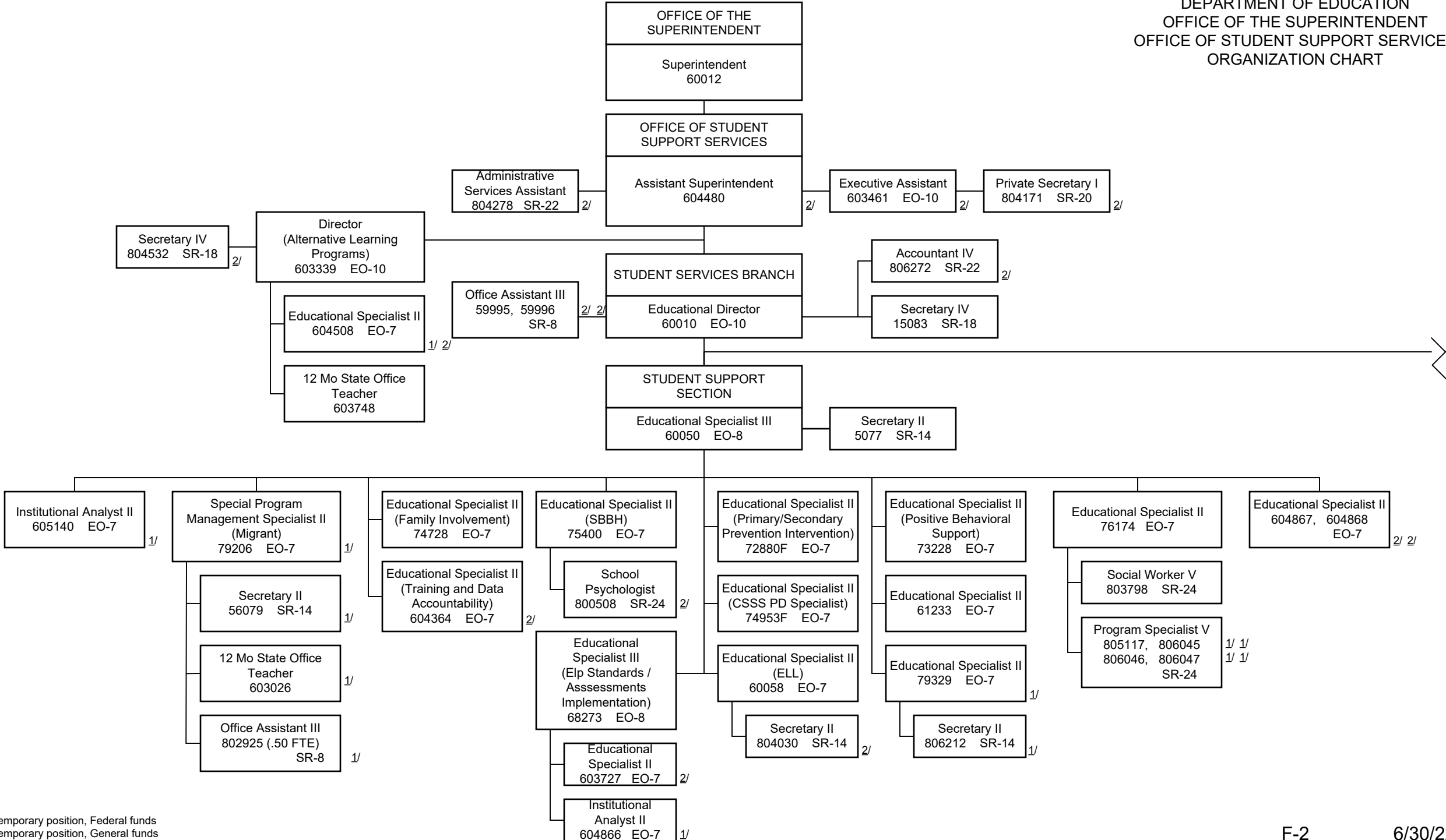

1/ Temporary position, Federal funds  
2/ Temporary position, General funds

STATE OF HAWAII  
 DEPARTMENT OF EDUCATION  
 OFFICE OF THE SUPERINTENDENT  
 OFFICE OF STUDENT SUPPORT SERVICES  
 ORGANIZATION CHART

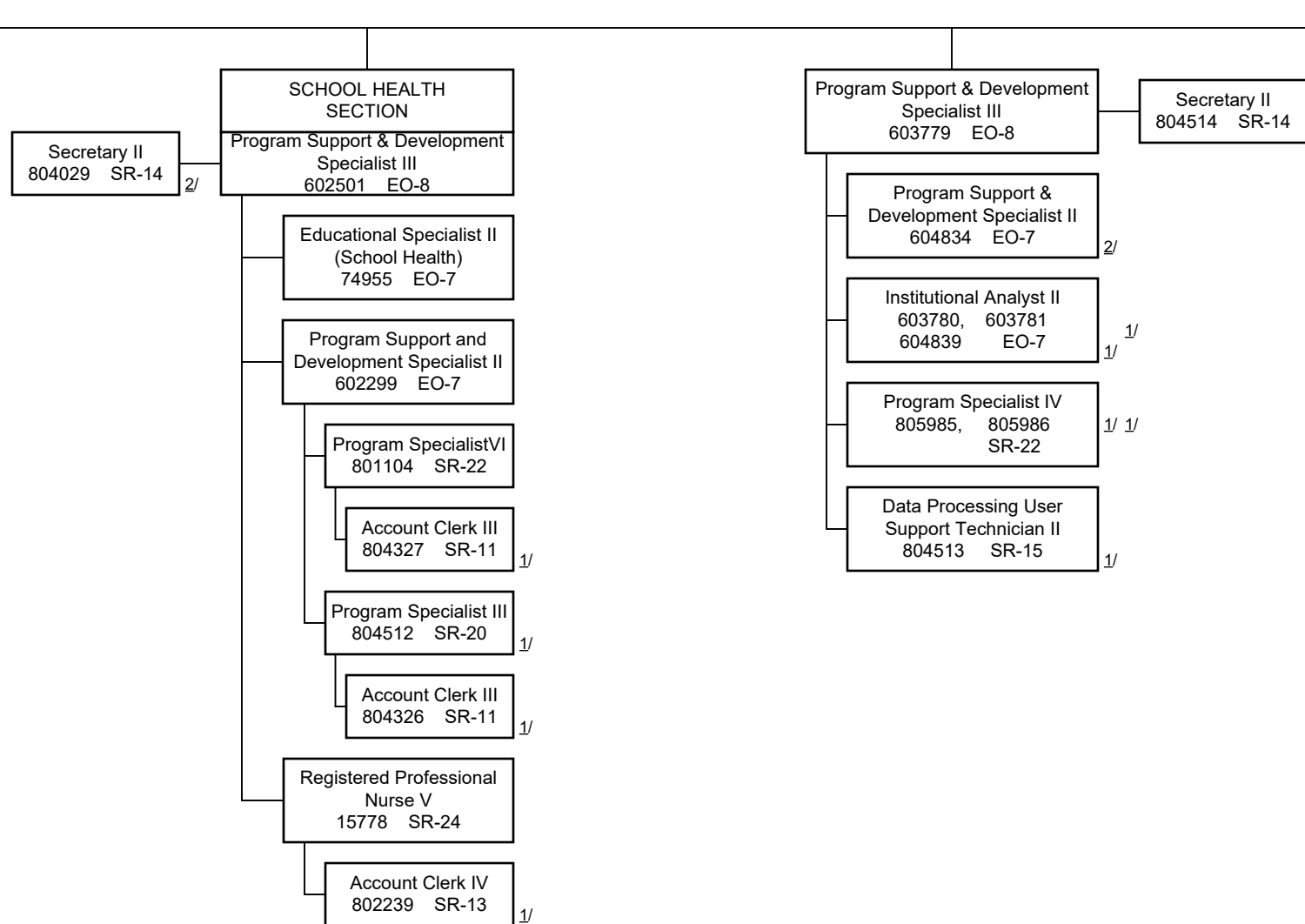

1/ Temporary position, Federal funds  
 2/ Temporary position, General funds

STATE OF HAWAII  
 DEPARTMENT OF EDUCATION  
 OFFICE OF THE SUPERINTENDENT  
 OFFICE OF STUDENT SUPPORT SERVICES  
 ORGANIZATION CHART

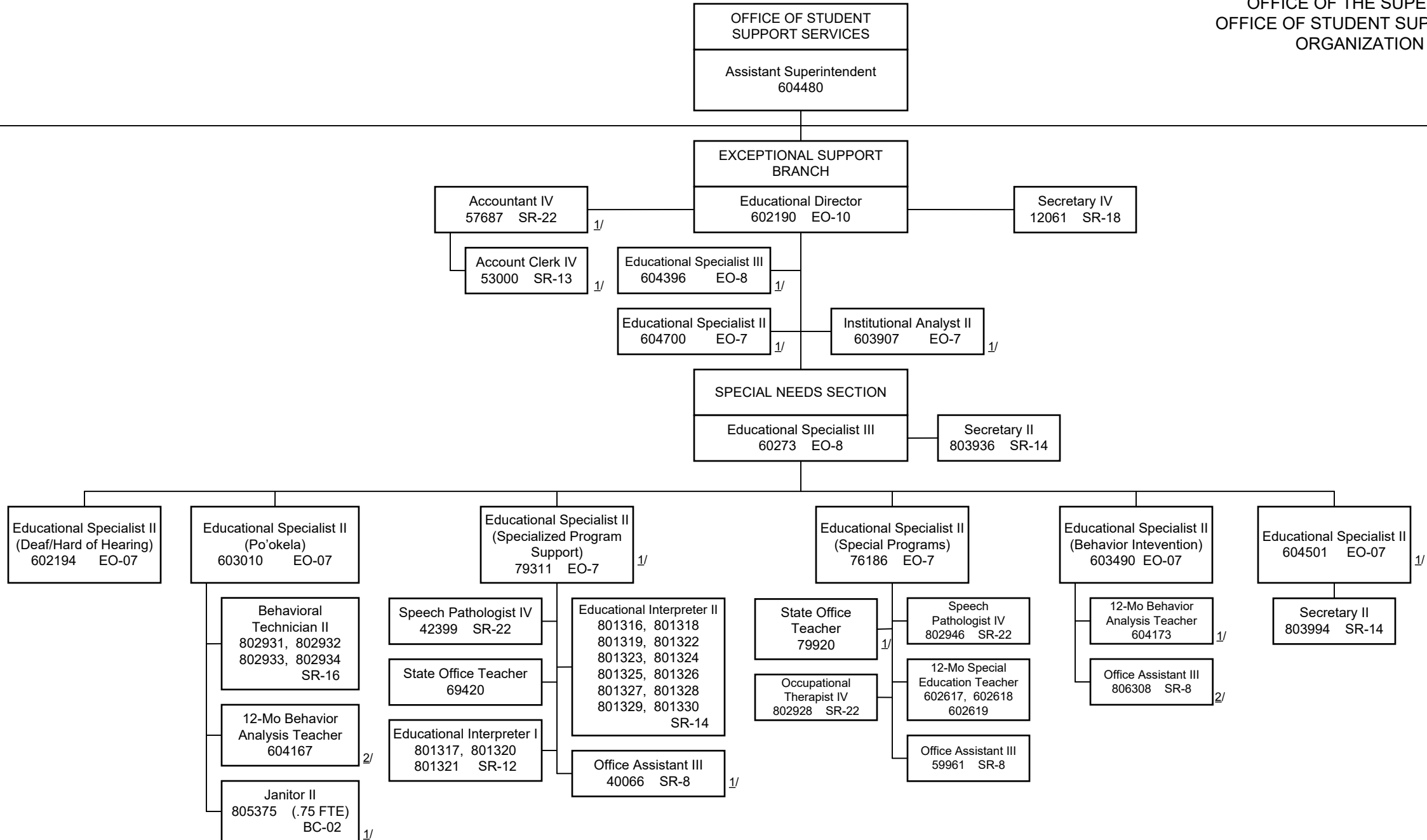

1/ Temporary position, Federal funds  
 2/ Temporary position, General funds

STATE OF HAWAII  
 DEPARTMENT OF EDUCATION  
 OFFICE OF THE SUPERINTENDENT  
 OFFICE OF STUDENT SUPPORT SERVICES  
 ORGANIZATION CHART

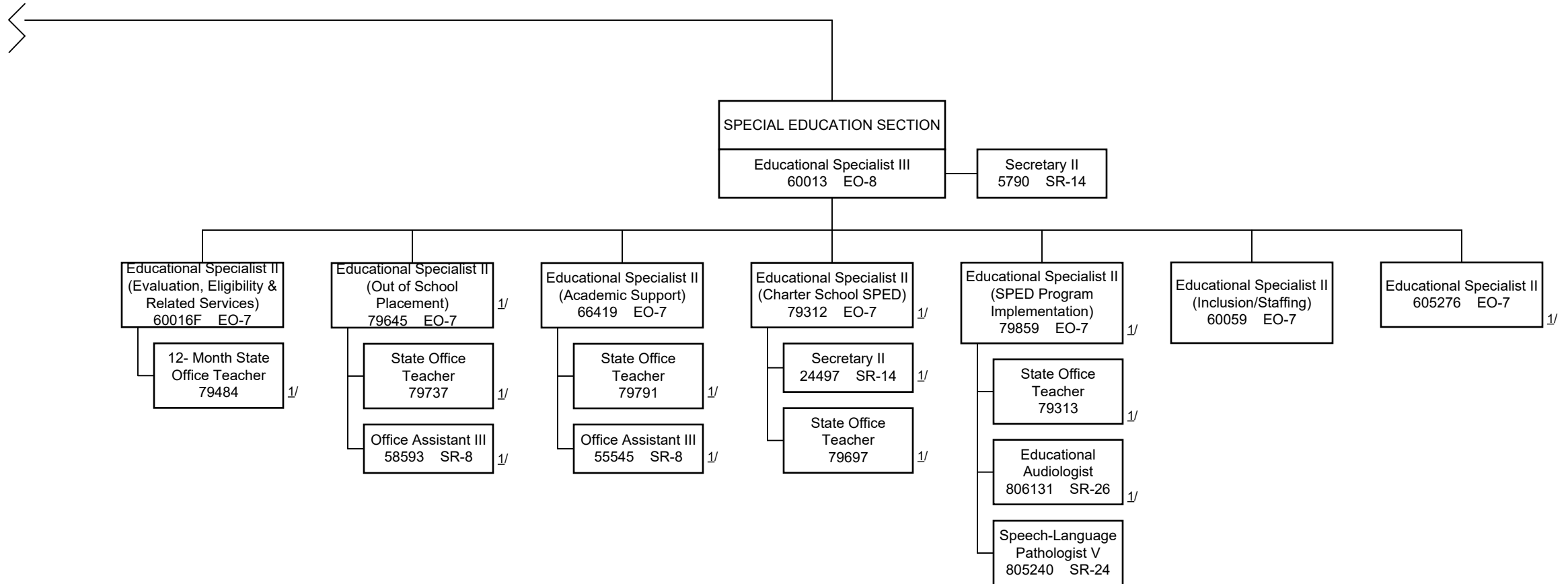

STATE OF HAWAII  
 DEPARTMENT OF EDUCATION  
 OFFICE OF THE SUPERINTENDENT  
 OFFICE OF FACILITIES AND OPERATIONS  
 ORGANIZATION CHART

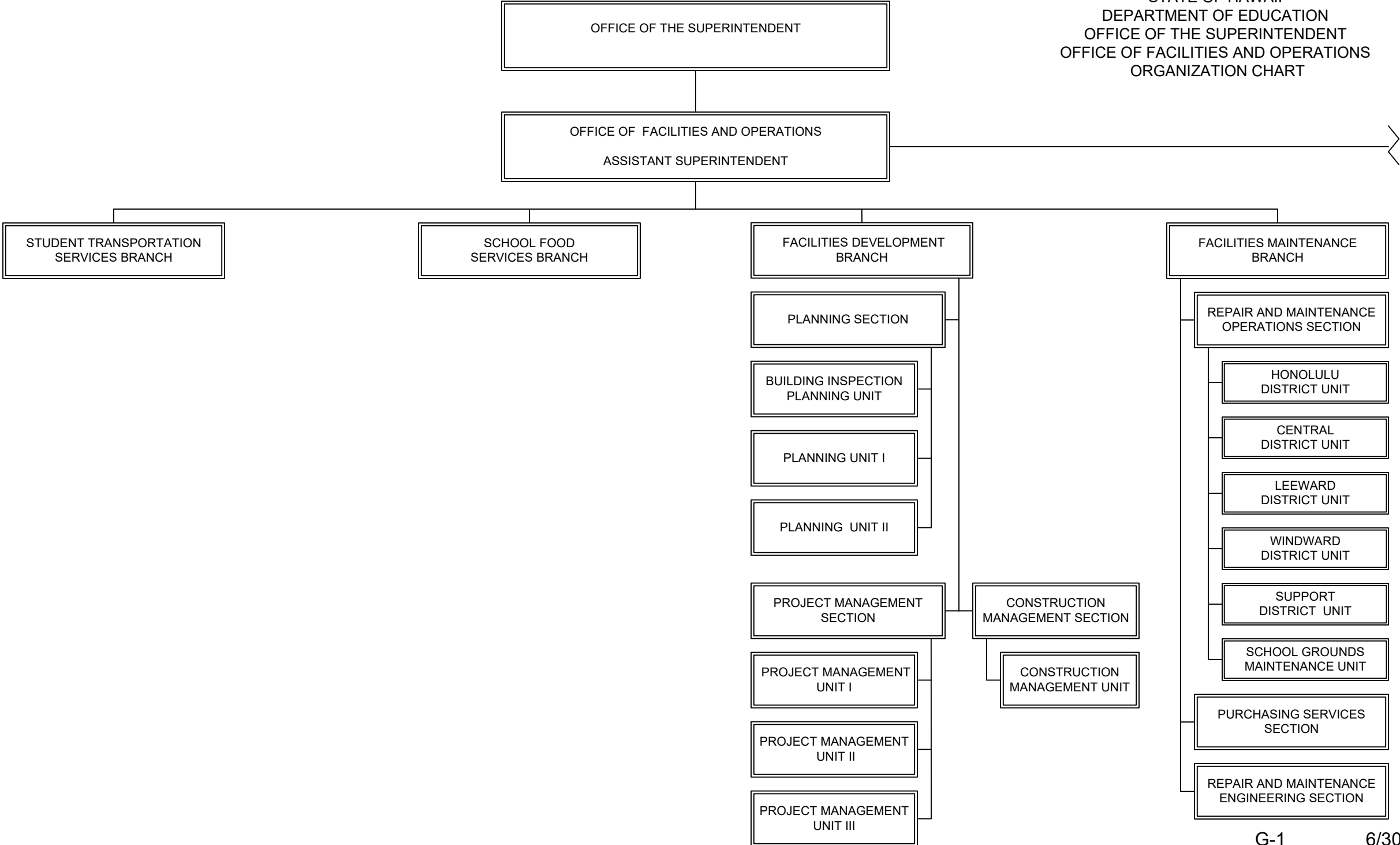



STATE OF HAWAII  
DEPARTMENT OF EDUCATION  
OFFICE OF THE SUPERINTENDENT  
OFFICE OF FACILITIES AND OPERATIONS  
ORGANIZATION CHART

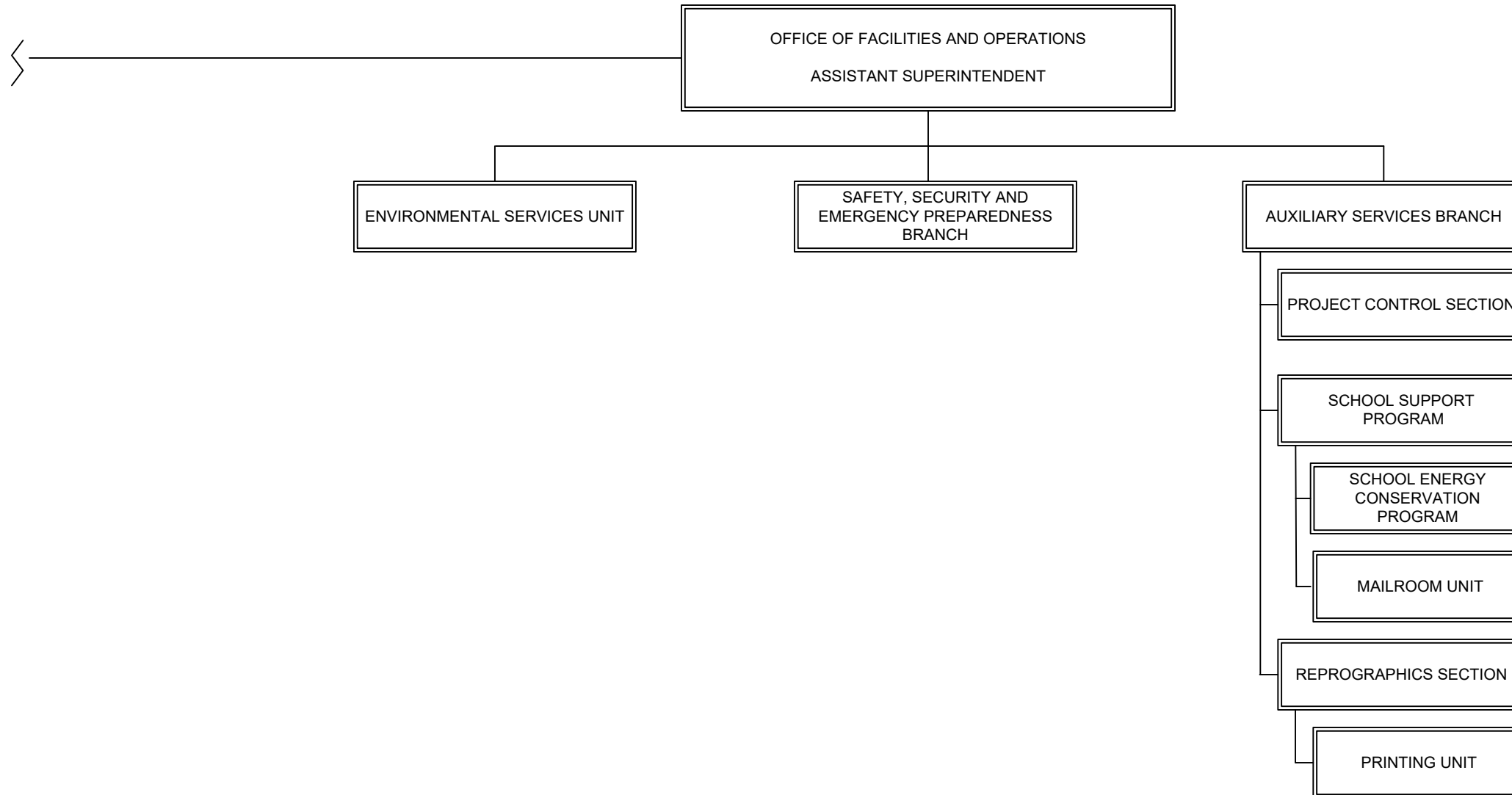

STATE OF HAWAII  
 DEPARTMENT OF EDUCATION  
 OFFICE OF THE SUPERINTENDENT  
 OFFICE OF FACILITIES AND OPERATIONS  
 ORGANIZATION CHART

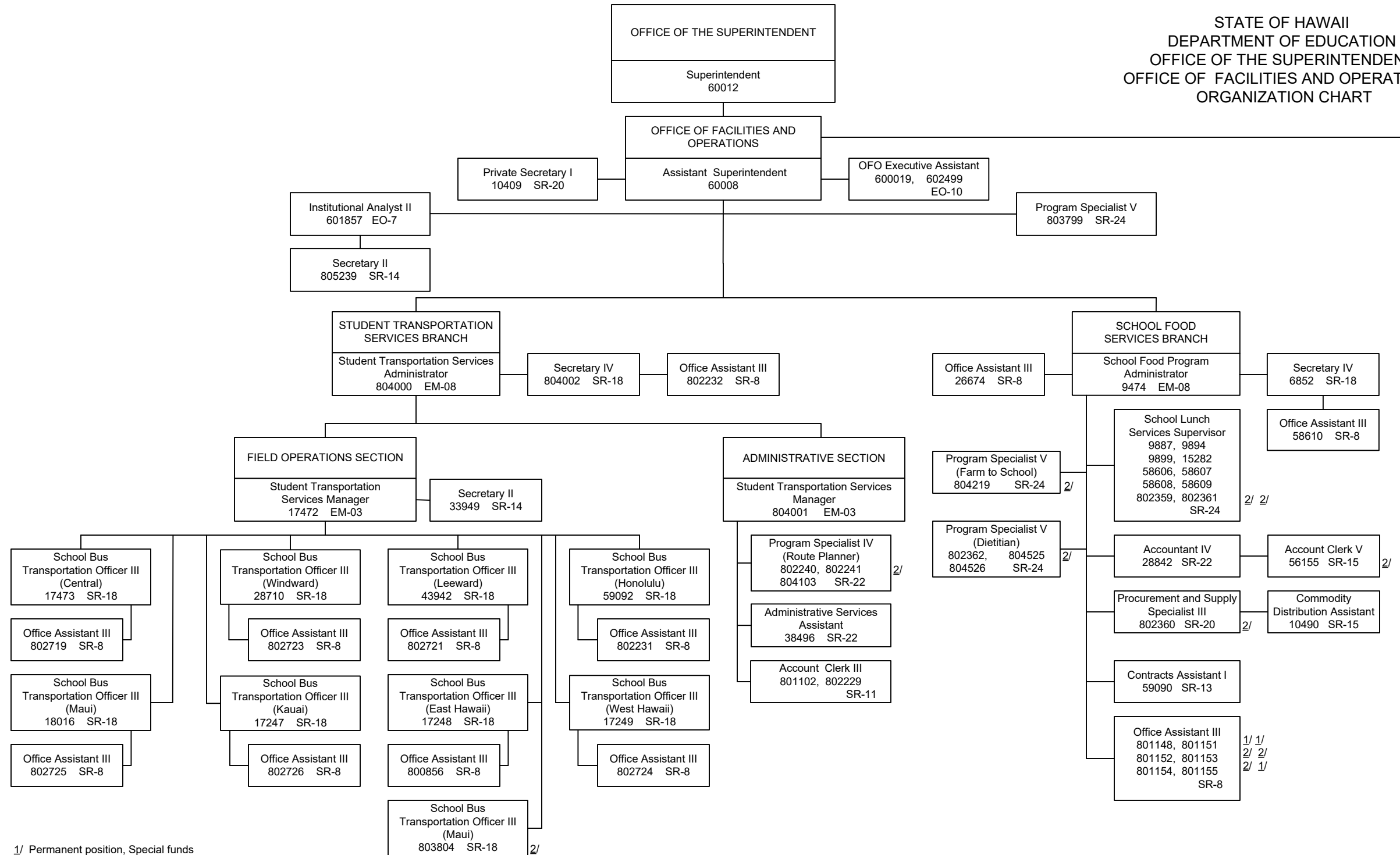

1/ Permanent position, Special funds  
 2/ Temporary position, Special funds

STATE OF HAWAII  
DEPARTMENT OF EDUCATION  
OFFICE OF THE SUPERINTENDENT  
OFFICE OF FACILITIES AND OPERATIONS  
ORGANIZATION CHART

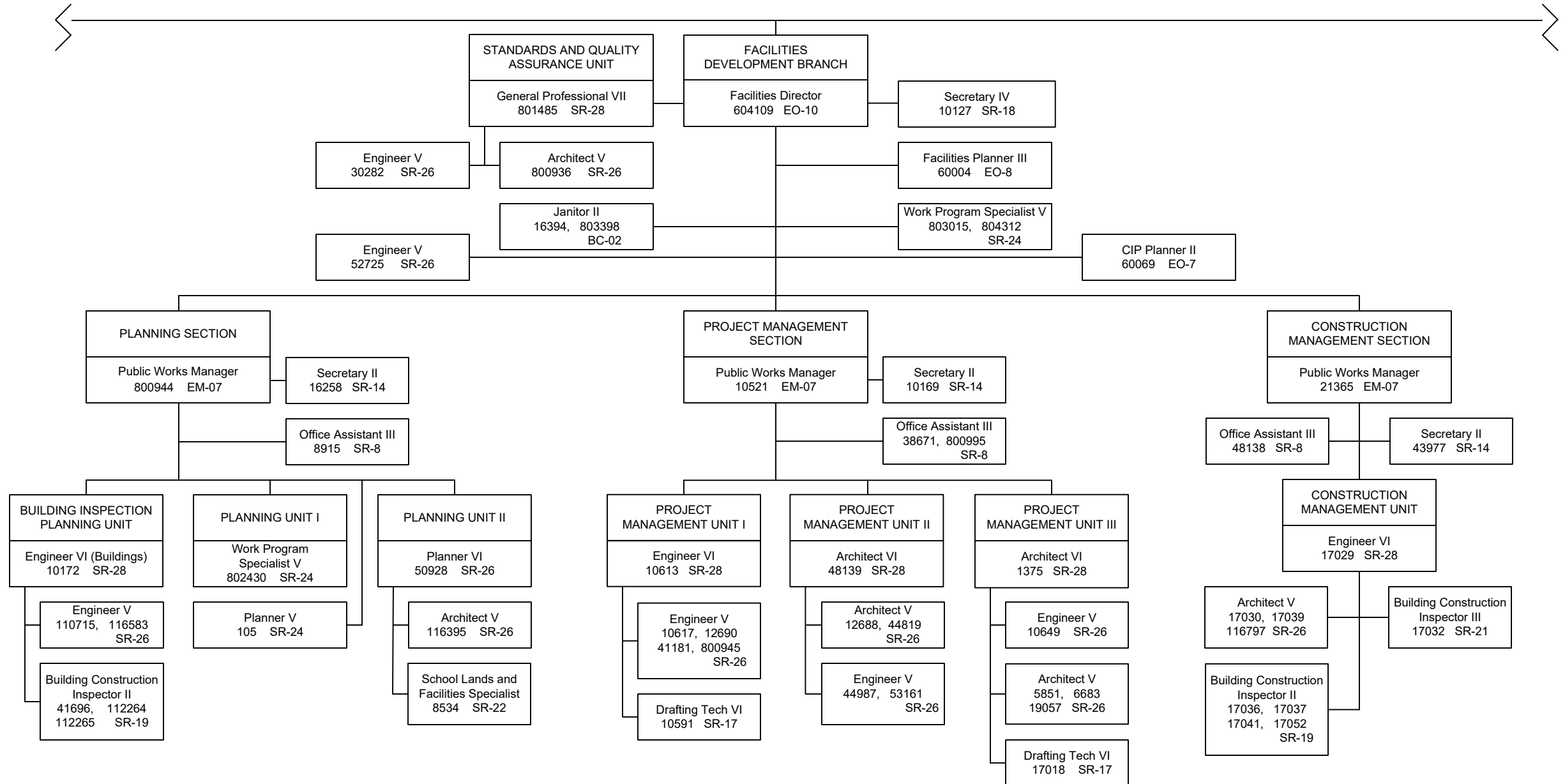

STATE OF HAWAII  
 DEPARTMENT OF EDUCATION  
 OFFICE OF THE SUPERINTENDENT  
 OFFICE OF FACILITIES AND OPERATIONS  
 ORGANIZATION CHART

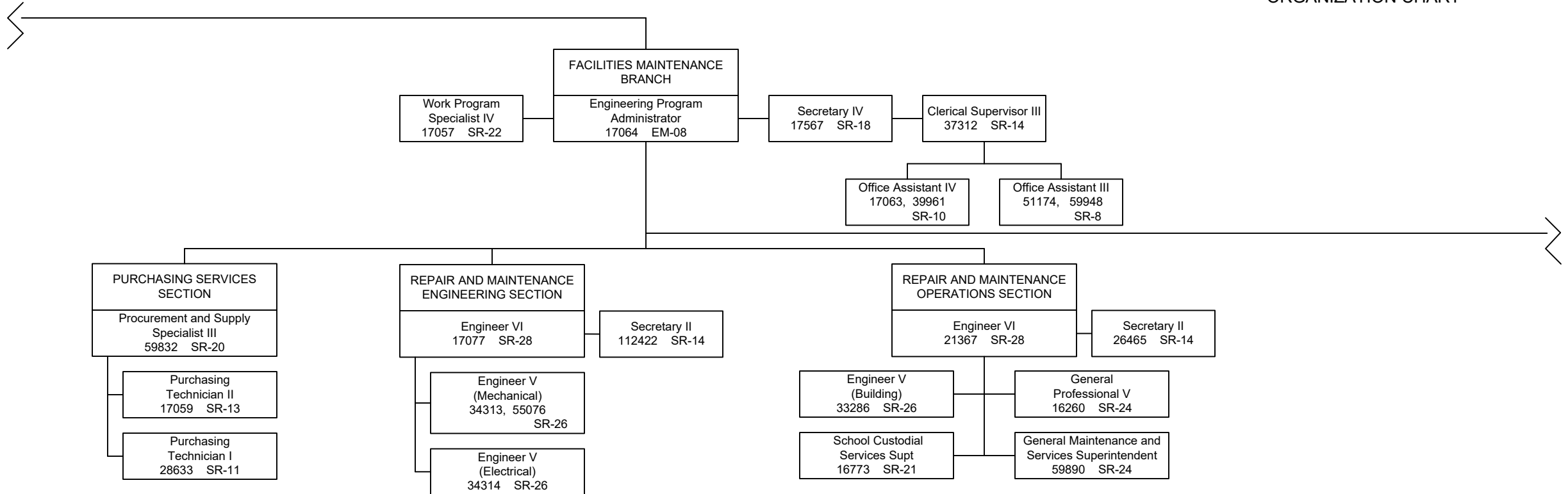

STATE OF HAWAII  
 DEPARTMENT OF EDUCATION  
 OFFICE OF THE SUPERINTENDENT  
 OFFICE OF FACILITIES AND OPERATIONS  
 ORGANIZATION CHART

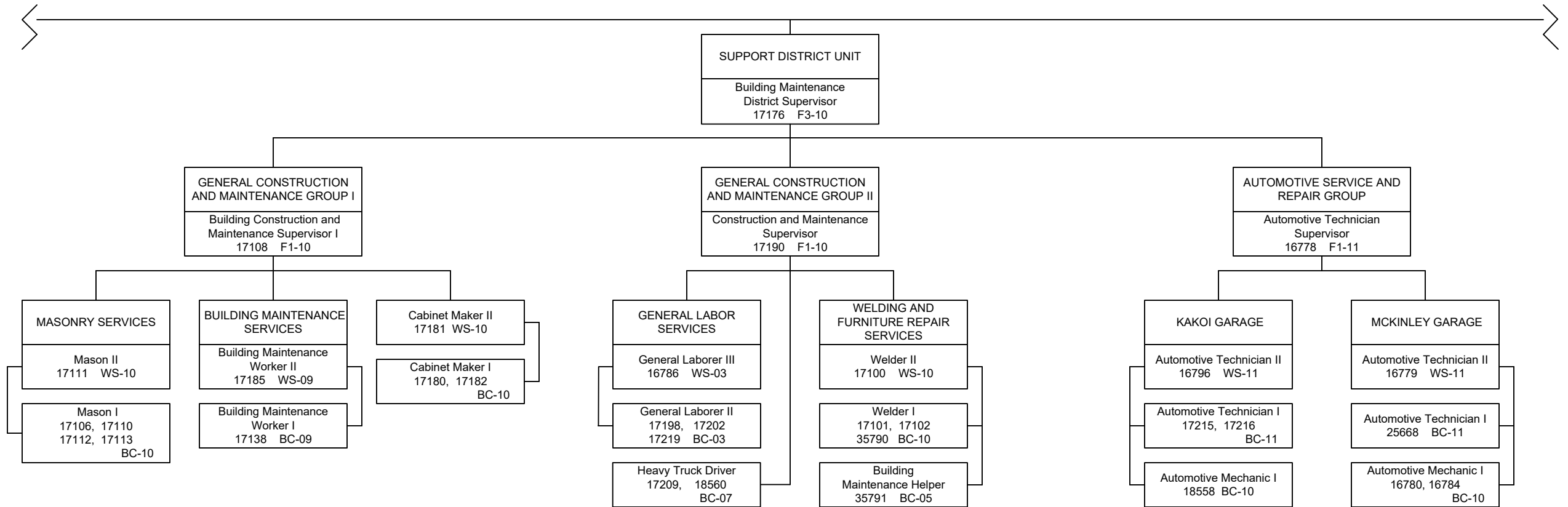

STATE OF HAWAII  
 DEPARTMENT OF EDUCATION  
 OFFICE OF THE SUPERINTENDENT  
 OFFICE OF FACILITIES AND OPERATIONS  
 ORGANIZATION CHART

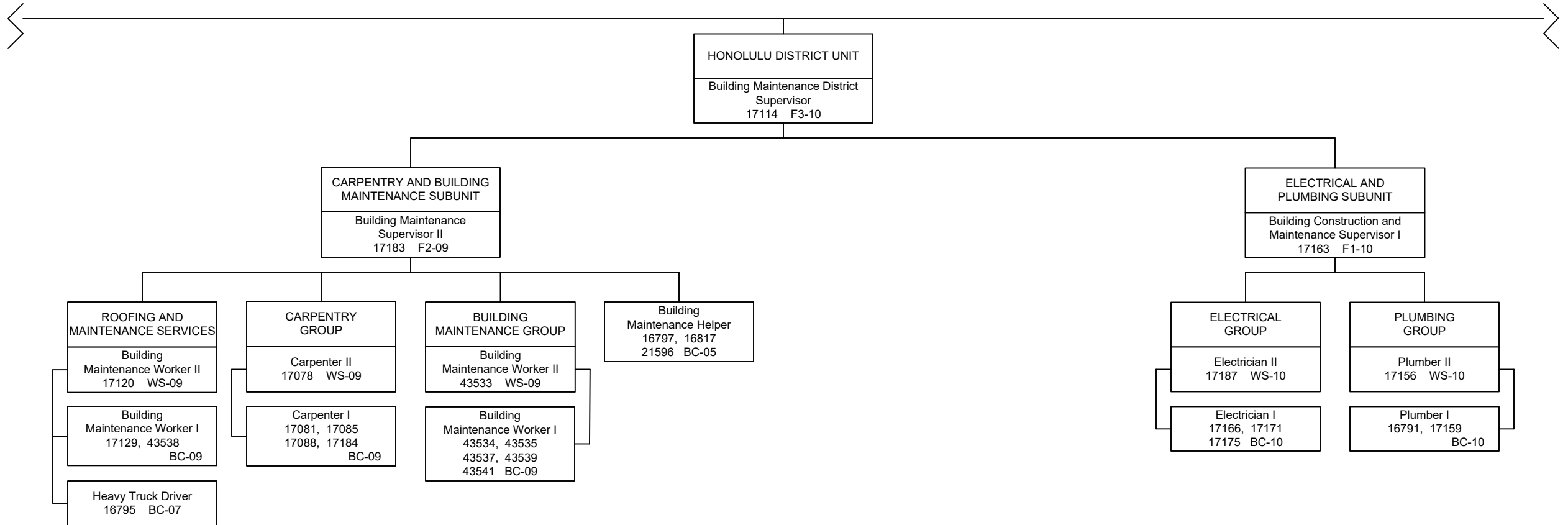

STATE OF HAWAII  
 DEPARTMENT OF EDUCATION  
 OFFICE OF THE SUPERINTENDENT  
 OFFICE OF FACILITIES AND OPERATIONS  
 ORGANIZATION CHART

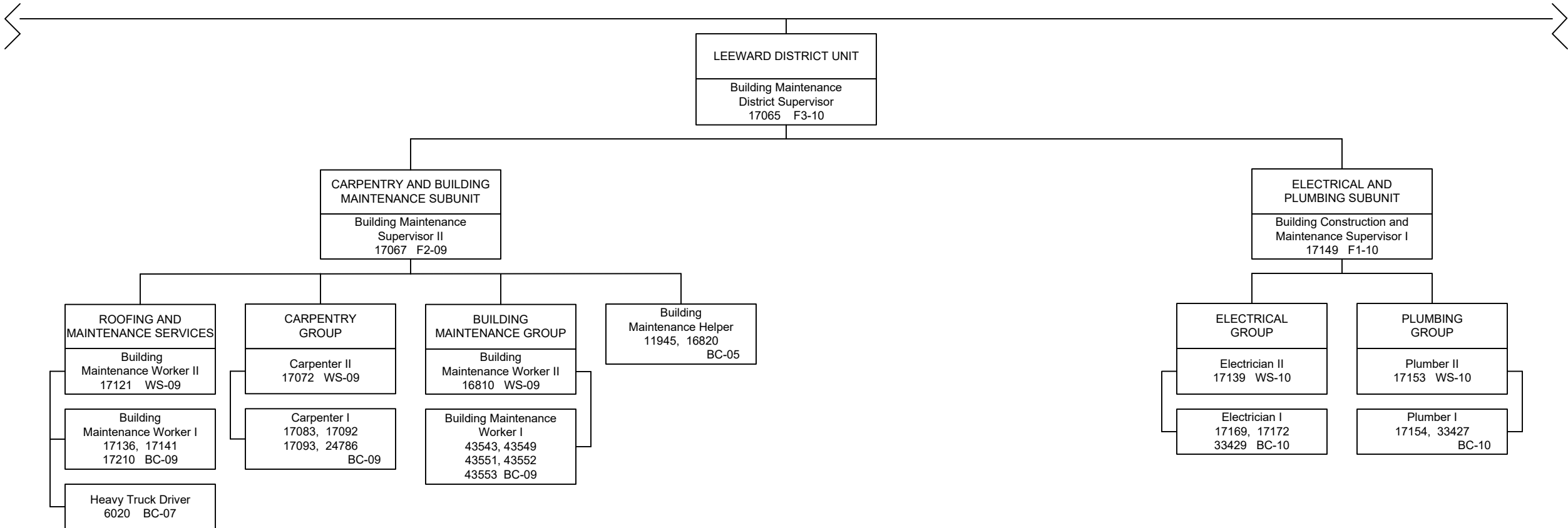

STATE OF HAWAII  
 DEPARTMENT OF EDUCATION  
 OFFICE OF THE SUPERINTENDENT  
 OFFICE OF FACILITIES AND OPERATIONS  
 ORGANIZATION CHART

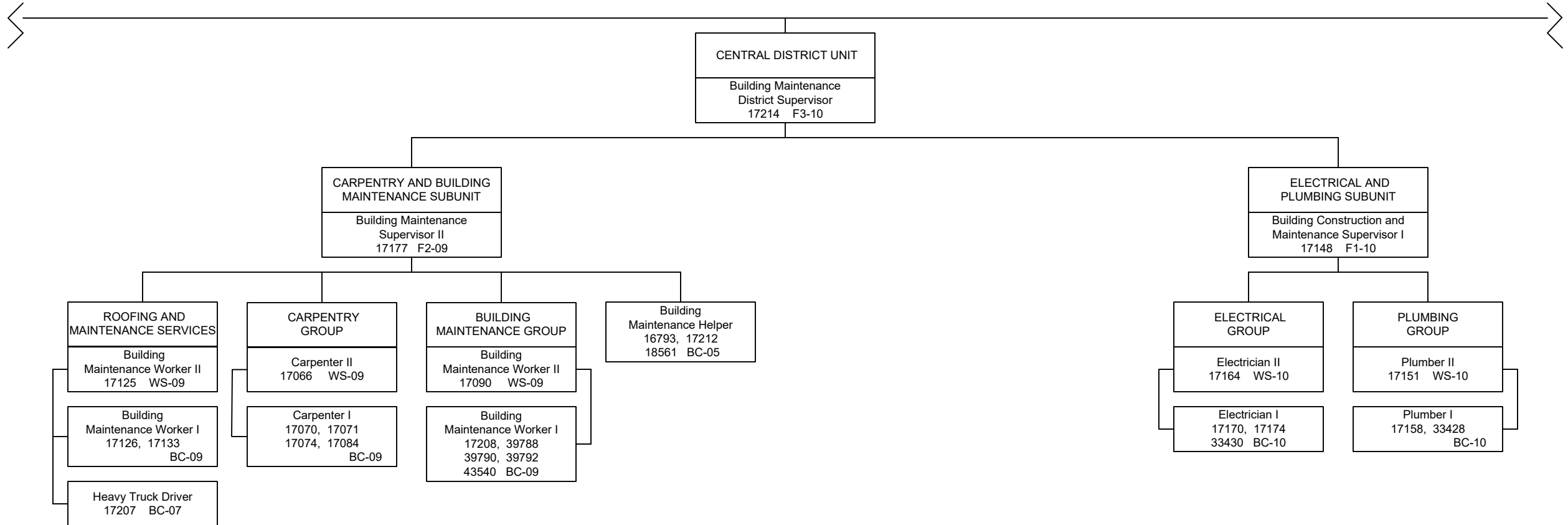



STATE OF HAWAII  
 DEPARTMENT OF EDUCATION  
 OFFICE OF THE SUPERINTENDENT  
 OFFICE OF FACILITIES AND OPERATIONS  
 ORGANIZATION CHART

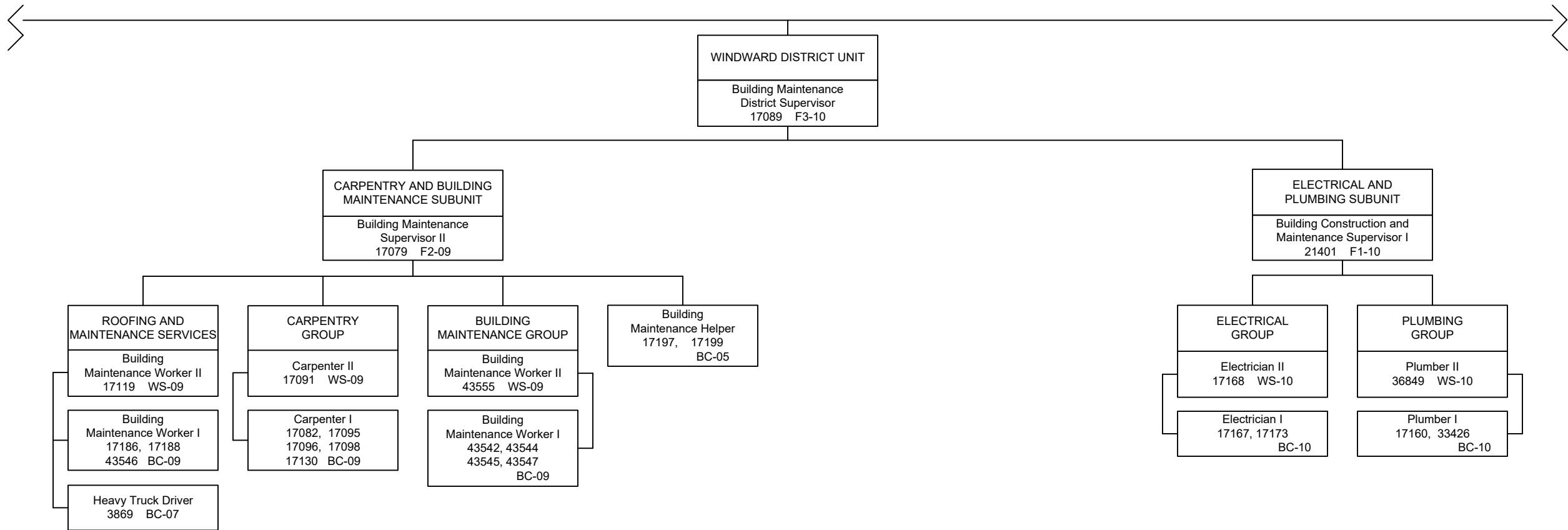

STATE OF HAWAII  
 DEPARTMENT OF EDUCATION  
 OFFICE OF THE SUPERINTENDENT  
 OFFICE OF FACILITIES AND OPERATIONS  
 ORGANIZATION CHART

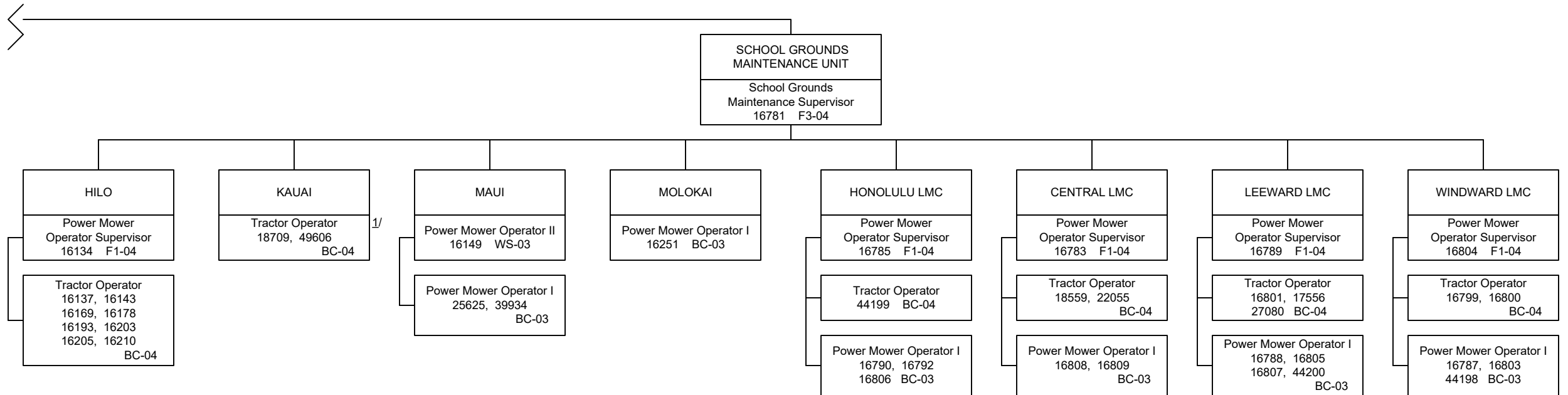

<sup>1/</sup> Positions receive administrative supervision by Business Management Officer I – 800812 (Kapaa/Kauai/Waimea Complex Area)

STATE OF HAWAII  
 DEPARTMENT OF EDUCATION  
 OFFICE OF THE SUPERINTENDENT  
 OFFICE OF FACILITIES AND OPERATIONS  
 ORGANIZATION CHART

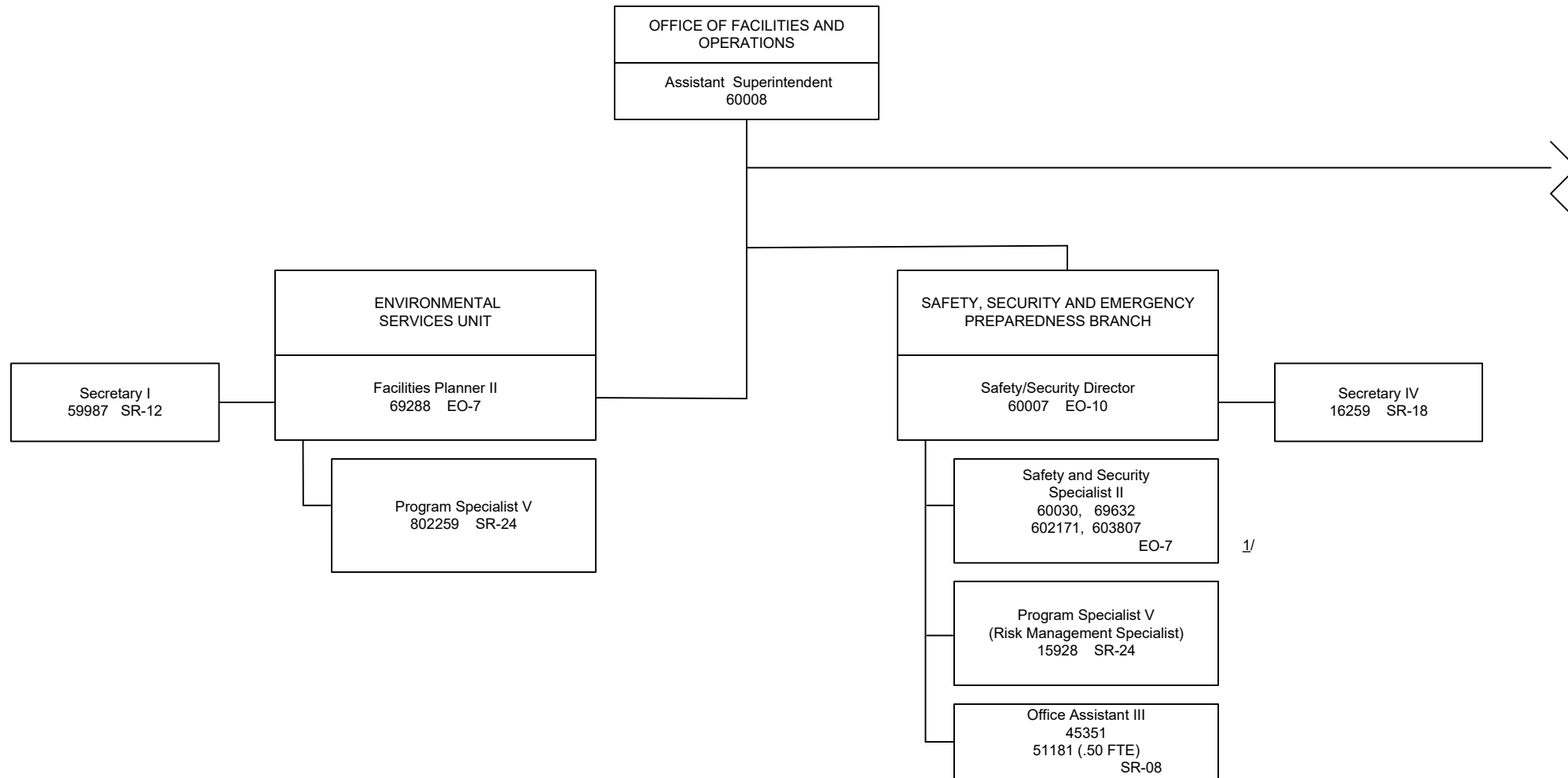

<sup>1/</sup> Temporary position, General funds

STATE OF HAWAII  
 DEPARTMENT OF EDUCATION  
 OFFICE OF THE SUPERINTENDENT  
 OFFICE OF FACILITIES AND OPERATIONS  
 ORGANIZATION CHART

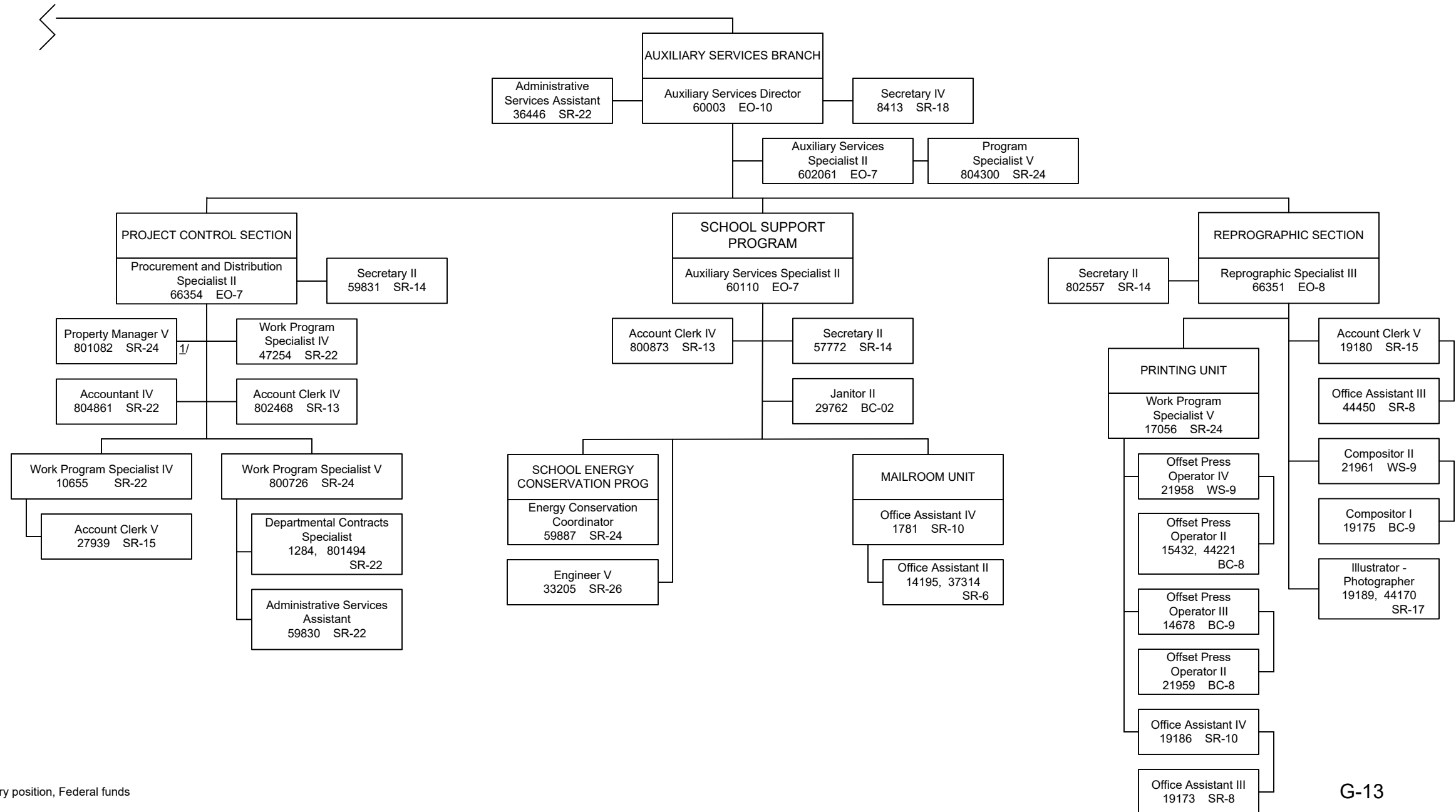

1/ Temporary position, Federal funds

STATE OF HAWAII  
DEPARTMENT OF EDUCATION  
OFFICE OF THE SUPERINTENDENT  
OFFICE OF FISCAL SERVICES  
ORGANIZATION CHART

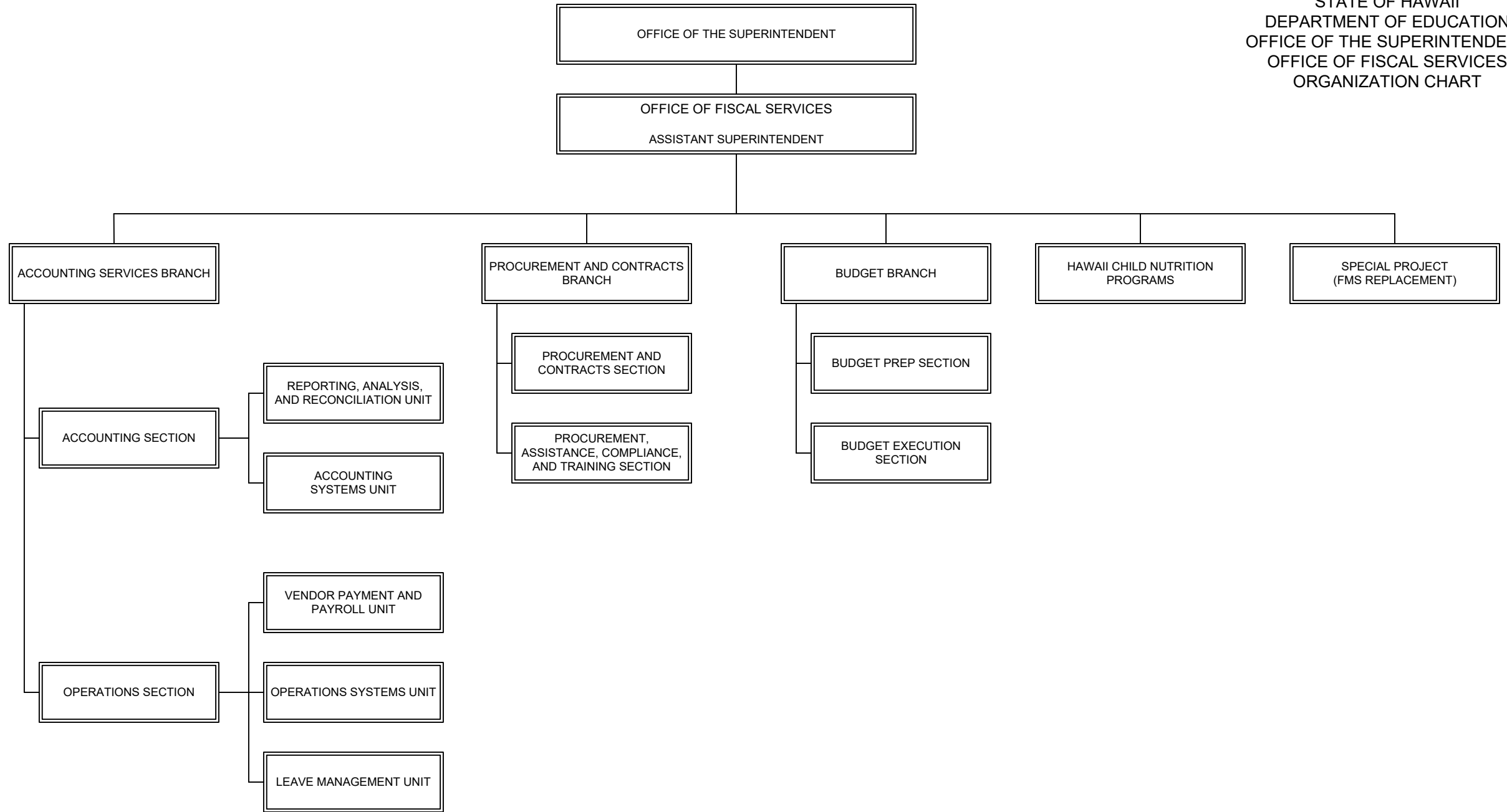

STATE OF HAWAII  
 DEPARTMENT OF EDUCATION  
 OFFICE OF THE SUPERINTENDENT  
 OFFICE OF FISCAL SERVICES  
 ORGANIZATION CHART

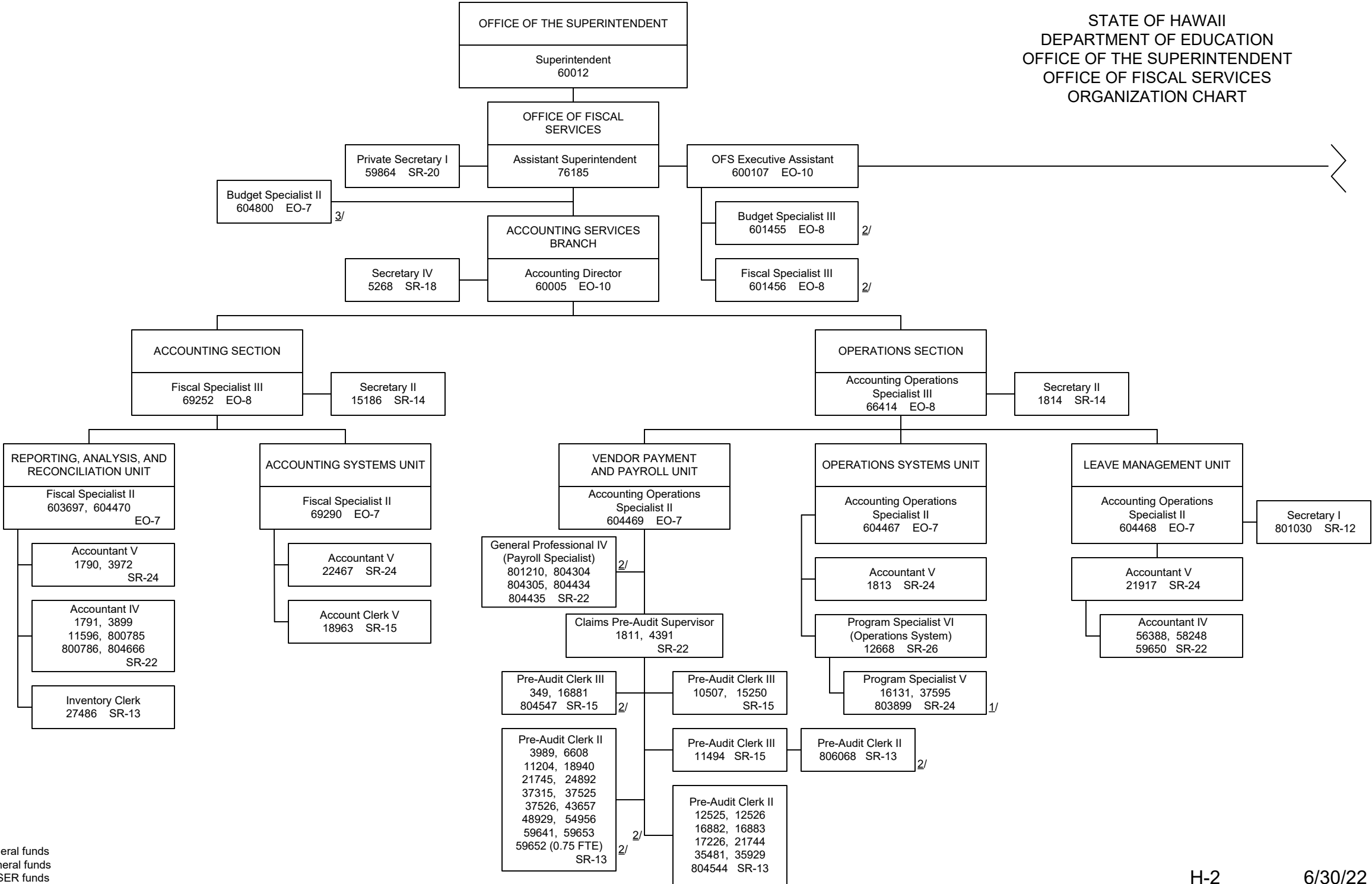

1/ Temporary position, Federal funds  
 2/ Temporary position, General funds  
 3/ Temporary position, ESSER funds

STATE OF HAWAII  
DEPARTMENT OF EDUCATION  
OFFICE OF THE SUPERINTENDENT  
OFFICE OF FISCAL SERVICES  
ORGANIZATION CHART

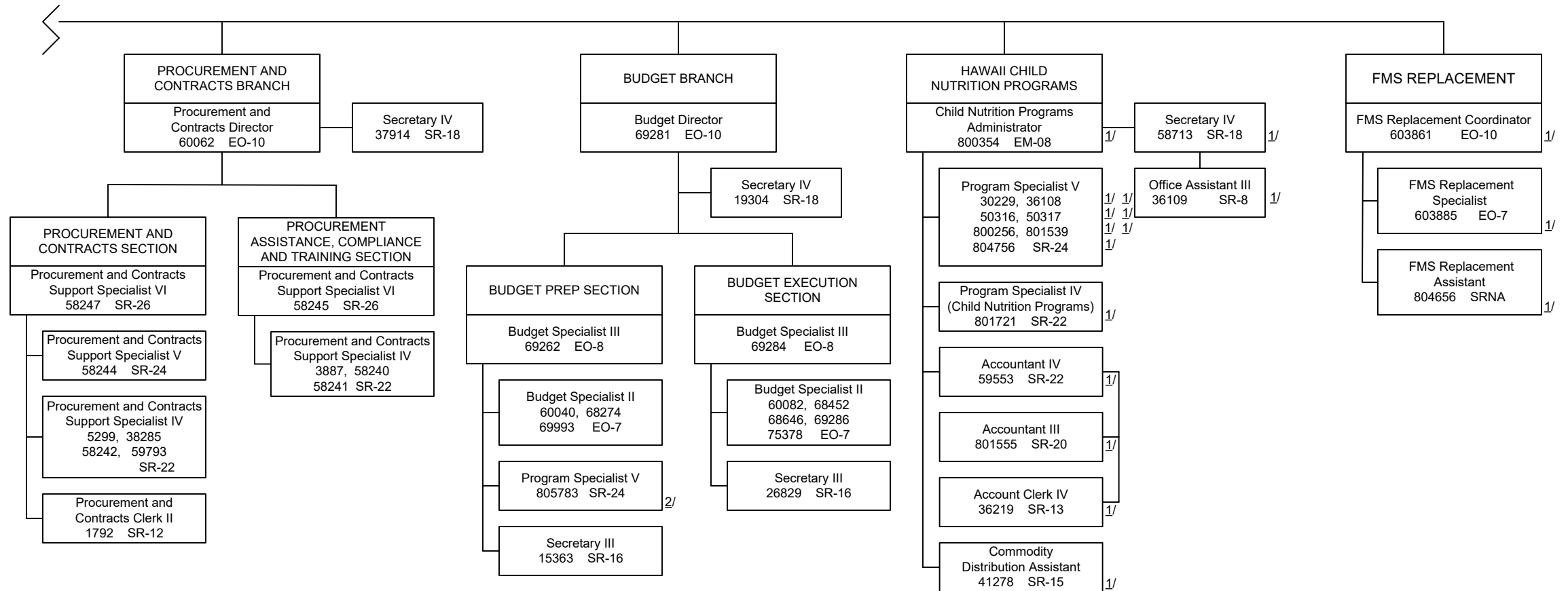

1/ Temporary position, Federal funds  
2/ Temporary position, General funds

STATE OF HAWAII  
 DEPARTMENT OF EDUCATION  
 OFFICE OF THE SUPERINTENDENT  
 OFFICE OF TALENT MANAGEMENT  
 ORGANIZATION CHART

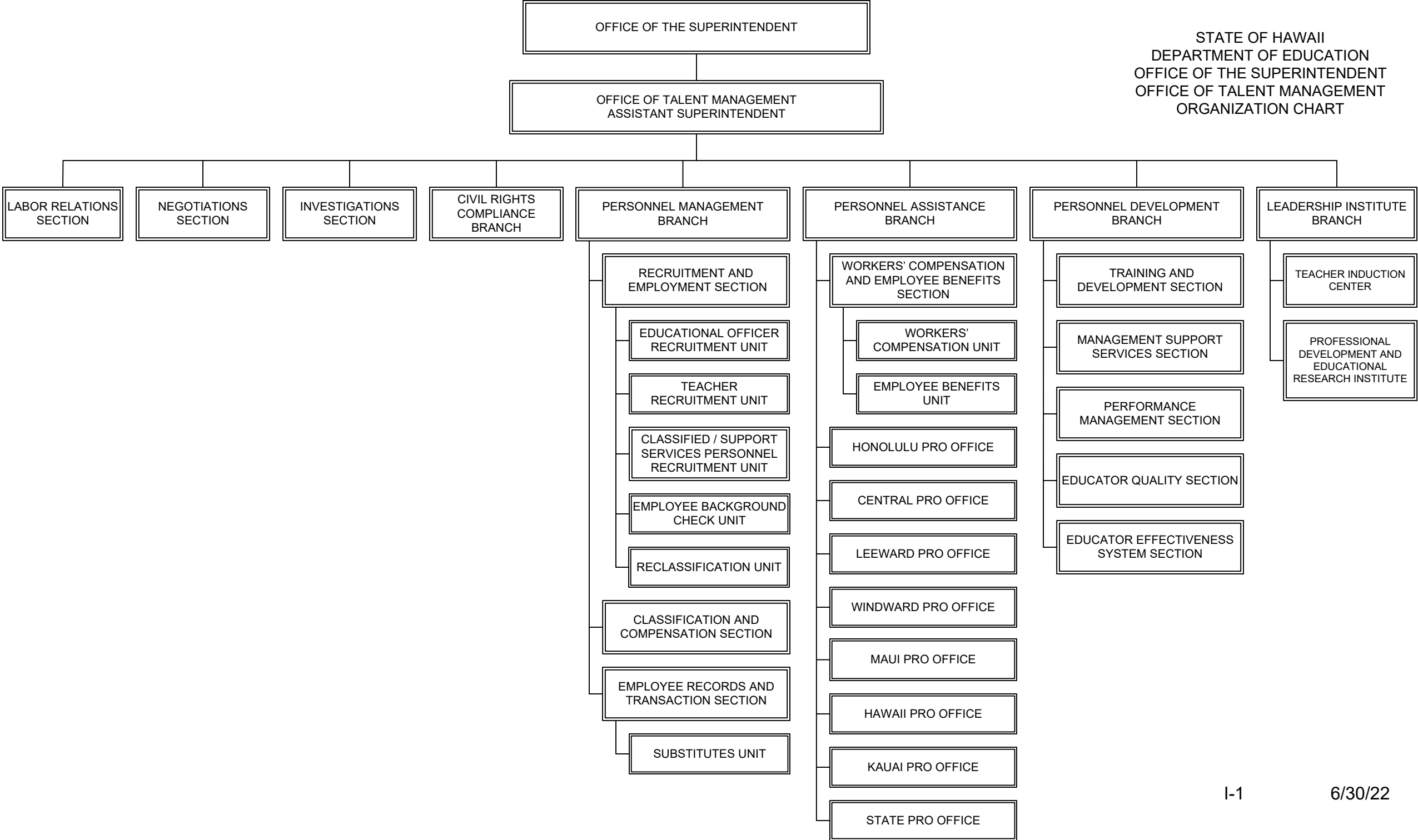



STATE OF HAWAII  
DEPARTMENT OF EDUCATION  
OFFICE OF THE SUPERINTENDENT  
OFFICE OF TALENT MANAGEMENT  
ORGANIZATION CHART

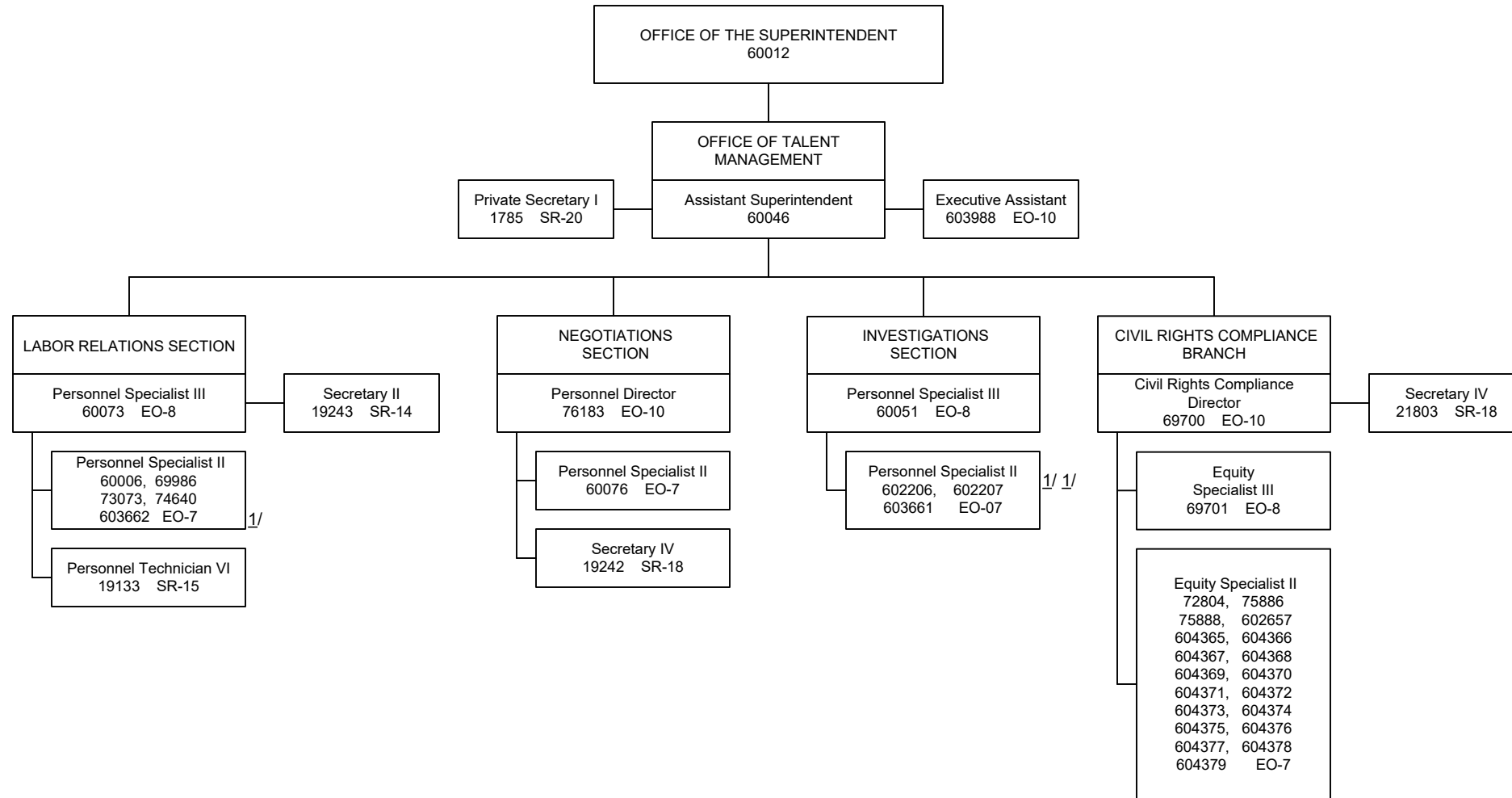

1/ Temporary position, General funds

STATE OF HAWAII  
DEPARTMENT OF EDUCATION  
OFFICE OF THE SUPERINTENDENT  
OFFICE OF TALENT MANAGEMENT  
ORGANIZATION CHART

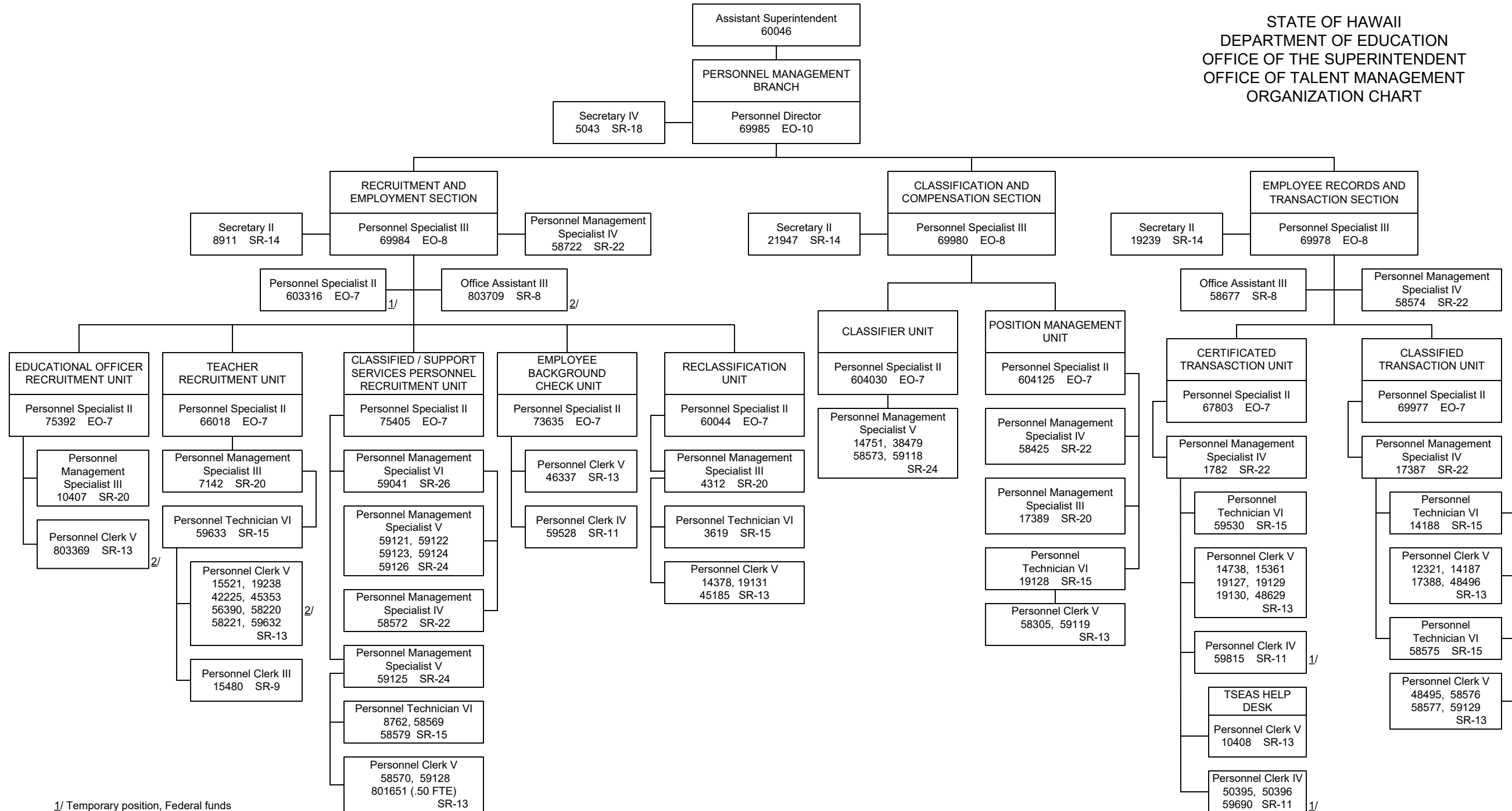

1/ Temporary position, Federal funds  
2/ Temporary position, General funds

STATE OF HAWAII  
DEPARTMENT OF EDUCATION  
OFFICE OF THE SUPERINTENDENT  
OFFICE OF TALENT MANAGEMENT  
ORGANIZATION CHART

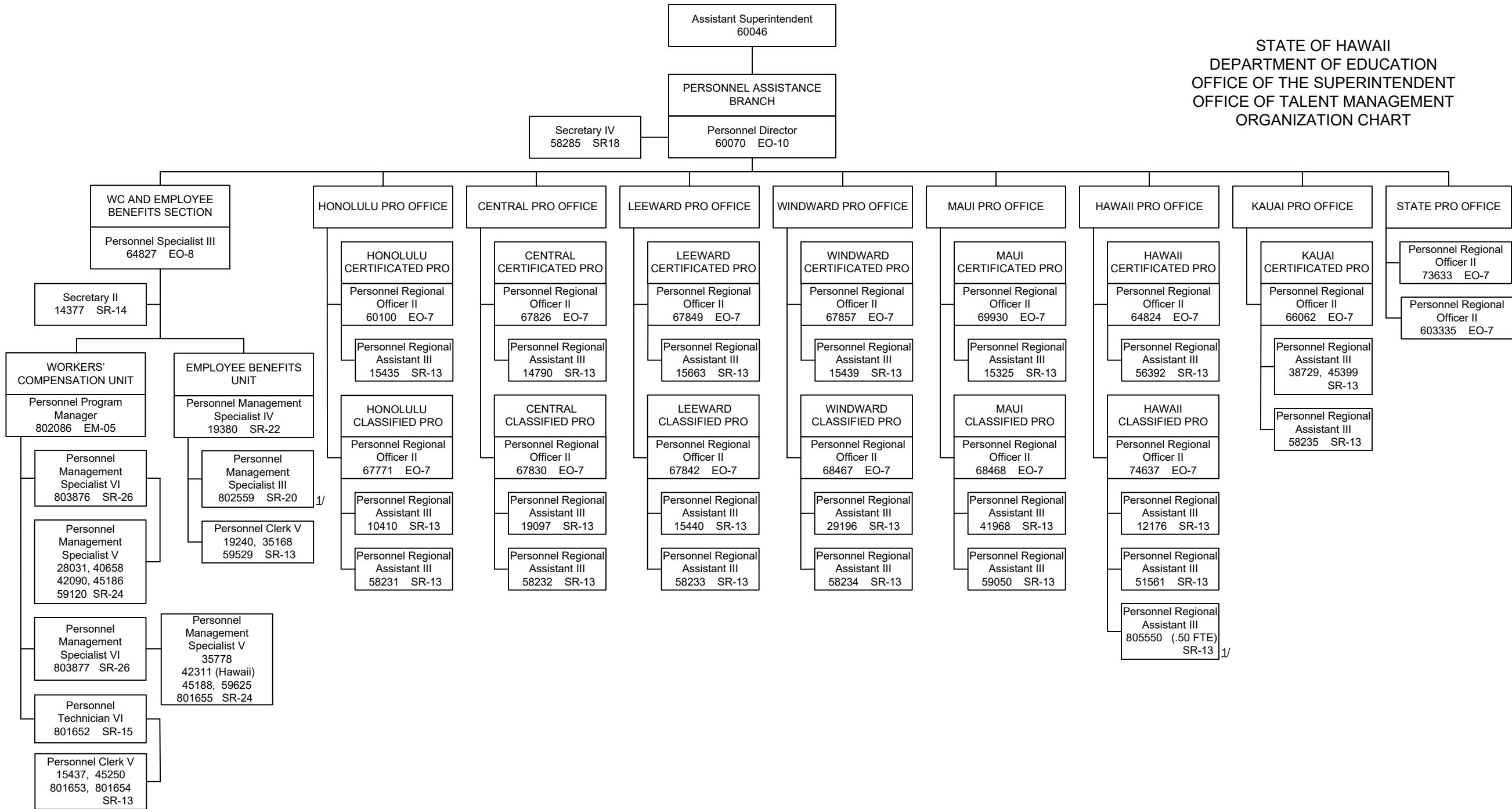

1/ Temporary position, General funds

STATE OF HAWAII  
 DEPARTMENT OF EDUCATION  
 OFFICE OF THE SUPERINTENDENT  
 OFFICE OF TALENT MANAGEMENT  
 ORGANIZATION CHART

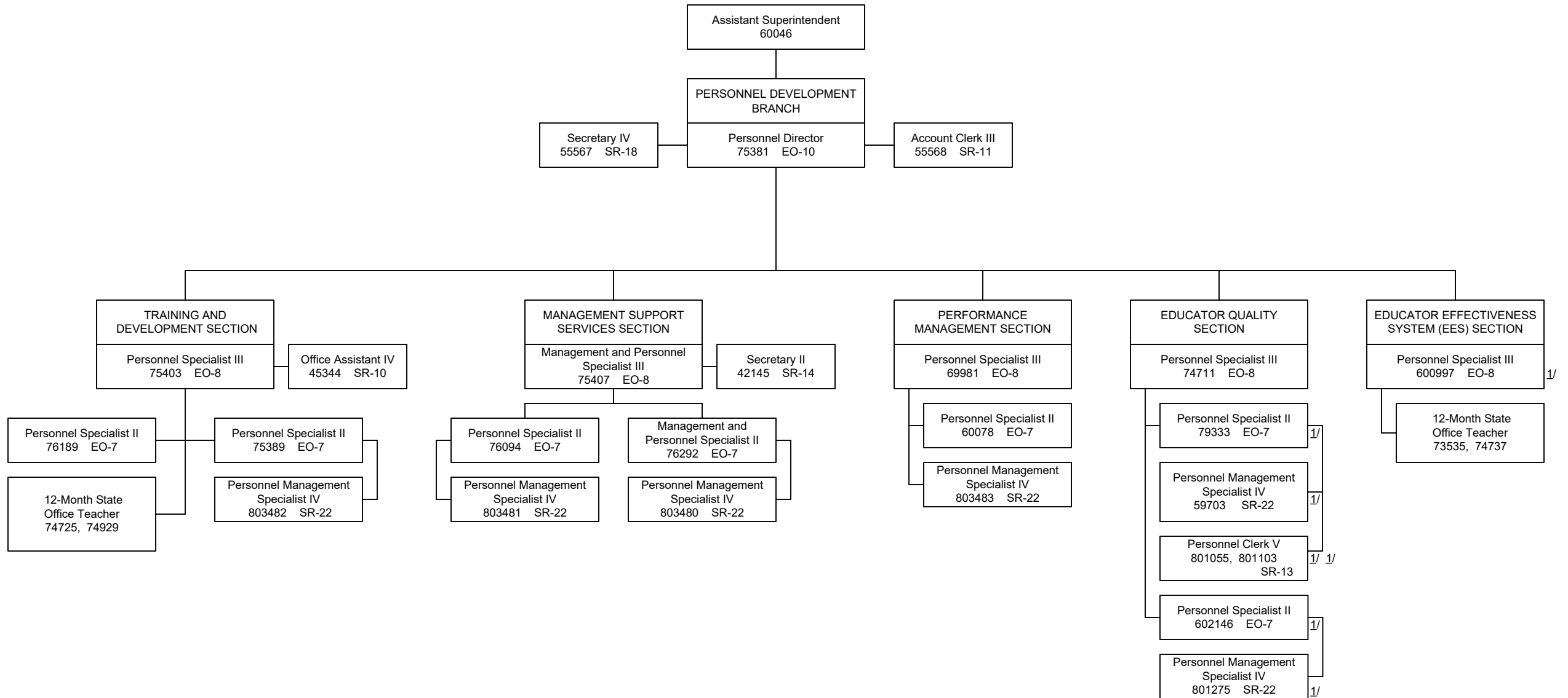

1/ Temporary position, Federal funds

STATE OF HAWAII  
 DEPARTMENT OF EDUCATION  
 OFFICE OF THE SUPERINTENDENT  
 OFFICE OF TALENT MANAGEMENT  
 ORGANIZATION CHART

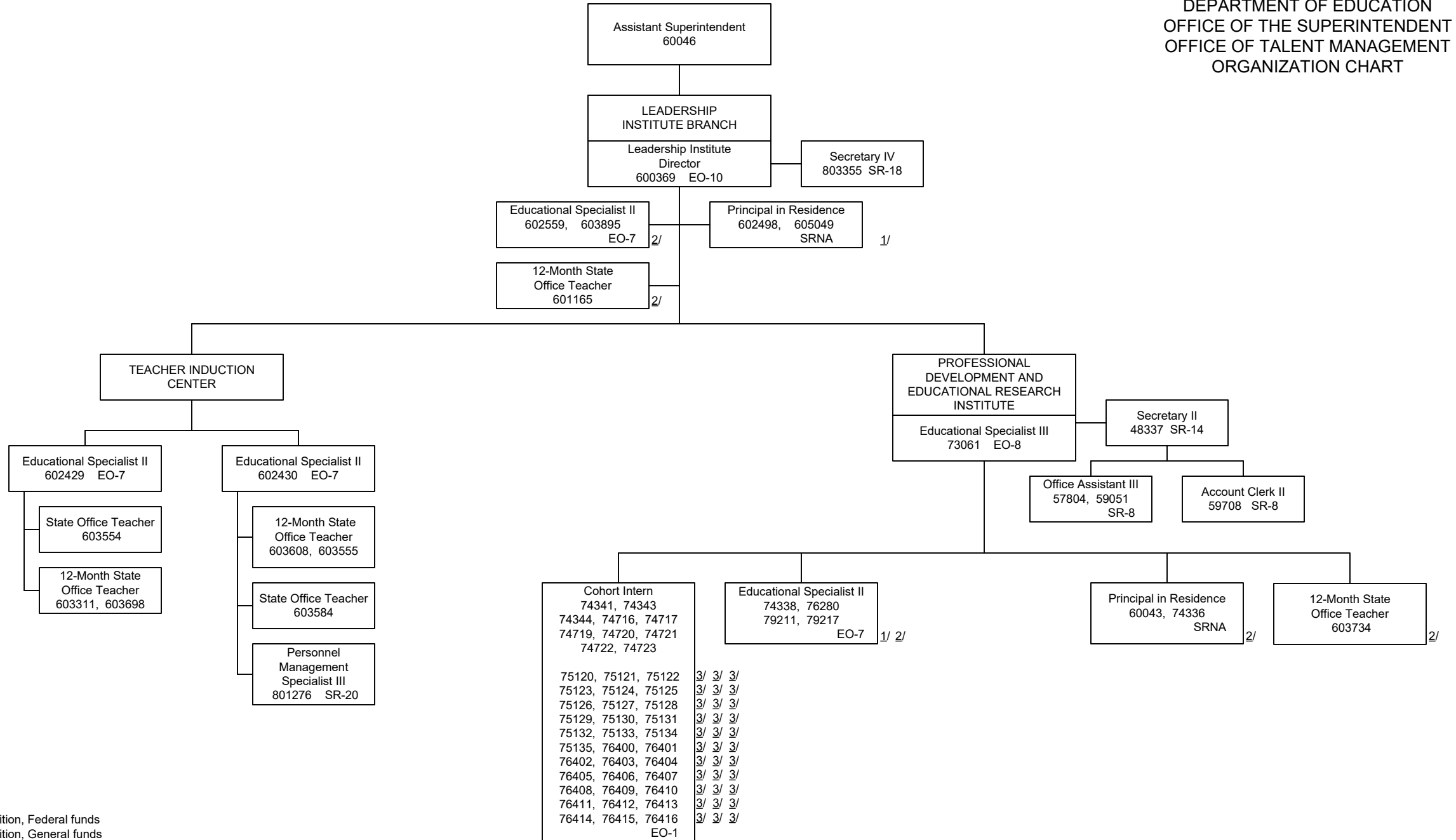

1/ Temporary position, Federal funds  
 2/ Temporary position, General funds  
 3/ Temporary Cohort Intern positions, General funds

STATE OF HAWAII  
 DEPARTMENT OF EDUCATION  
 OFFICE OF THE SUPERINTENDENT  
 OFFICE OF INFORMATION TECHNOLOGY SERVICES  
 ORGANIZATION CHART

OFFICE OF INFORMATION TECHNOLOGY SERVICES  
 ASSISTANT SUPERINTENDENT

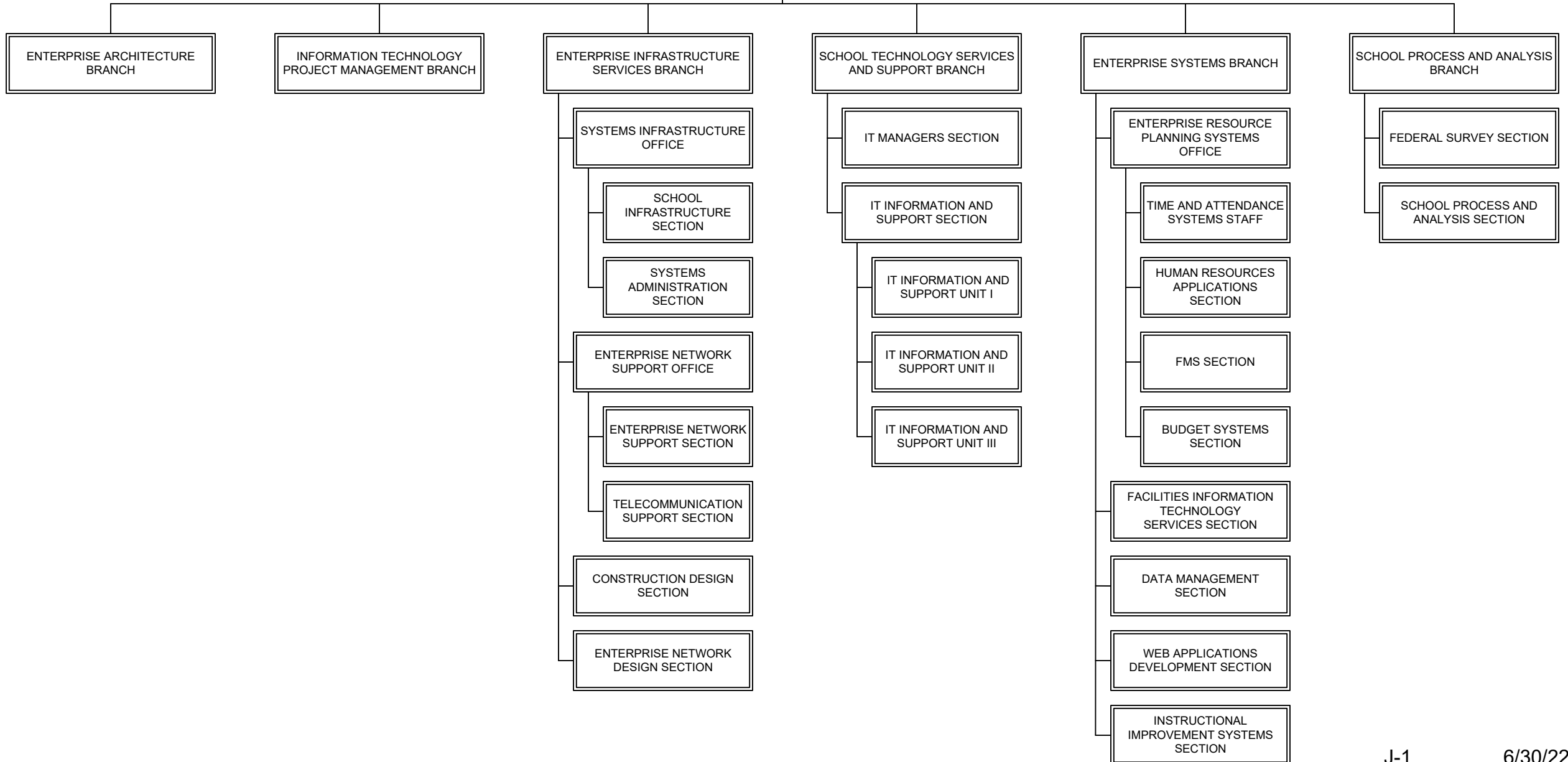

STATE OF HAWAII  
 DEPARTMENT OF EDUCATION  
 OFFICE OF THE SUPERINTENDENT  
 OFFICE OF INFORMATION TECHNOLOGY SERVICES  
 ORGANIZATION CHART

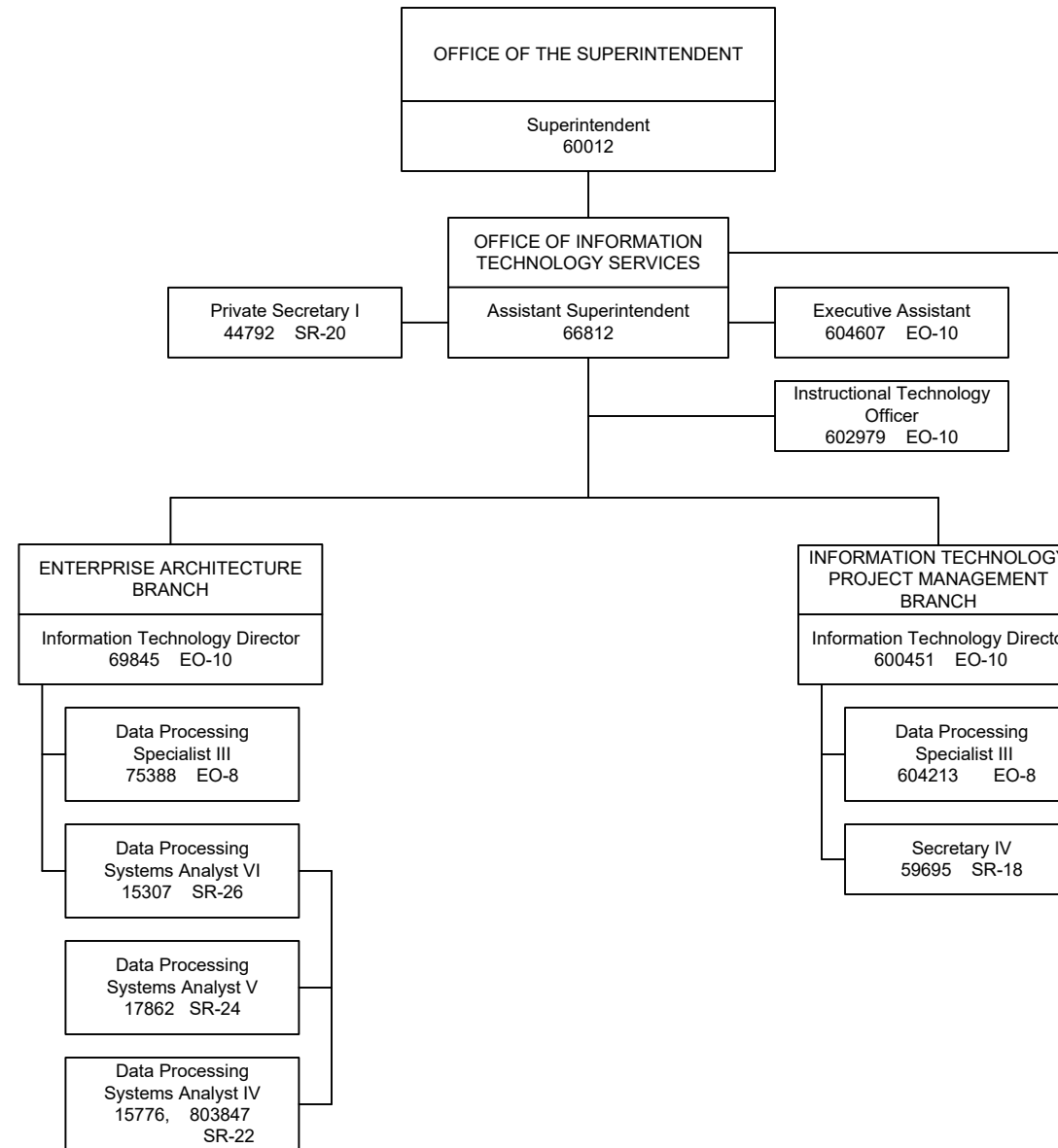

STATE OF HAWAII  
DEPARTMENT OF EDUCATION  
OFFICE OF THE SUPERINTENDENT  
OFFICE OF INFORMATION TECHNOLOGY SERVICES  
ORGANIZATION CHART

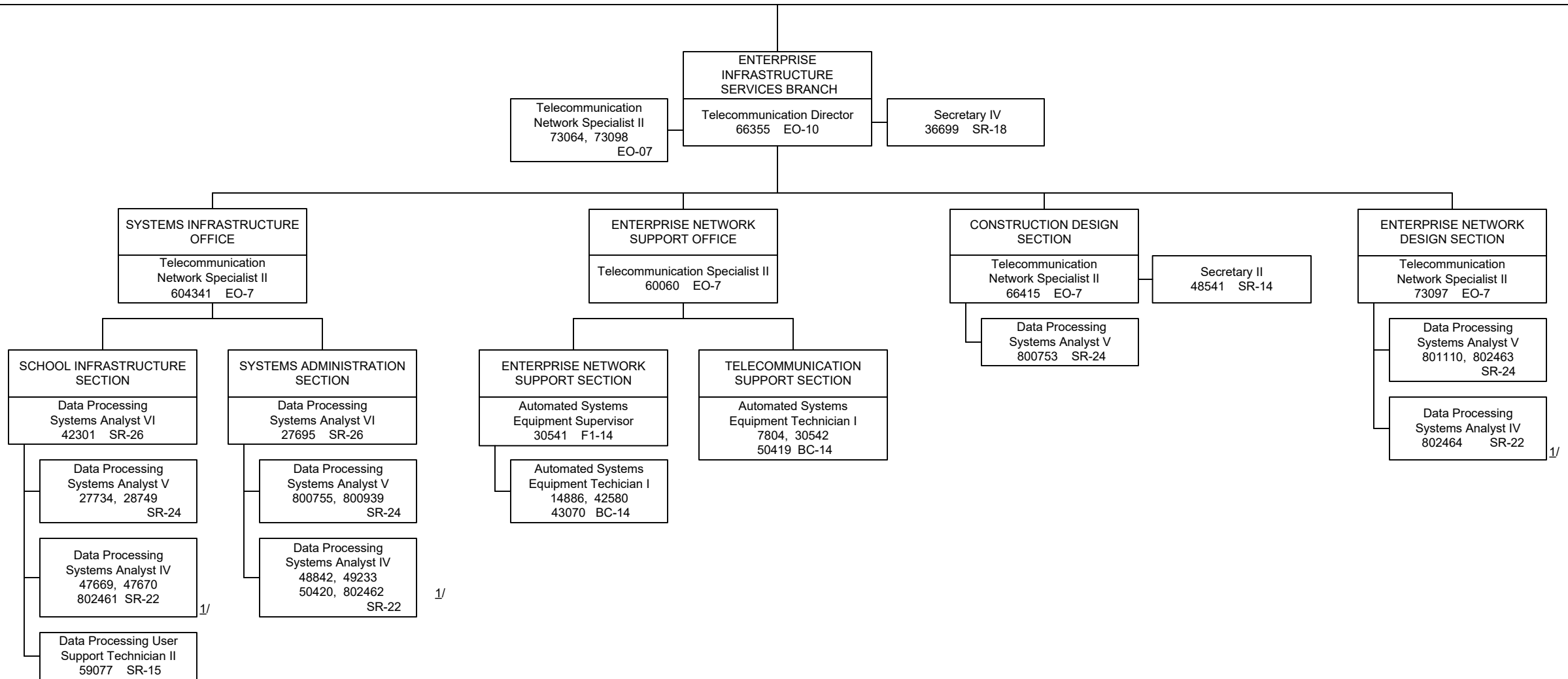

<sup>1/</sup> Temporary position, General funds



STATE OF HAWAII  
 DEPARTMENT OF EDUCATION  
 OFFICE OF THE SUPERINTENDENT  
 OFFICE OF INFORMATION TECHNOLOGY SERVICES  
 ORGANIZATION CHART

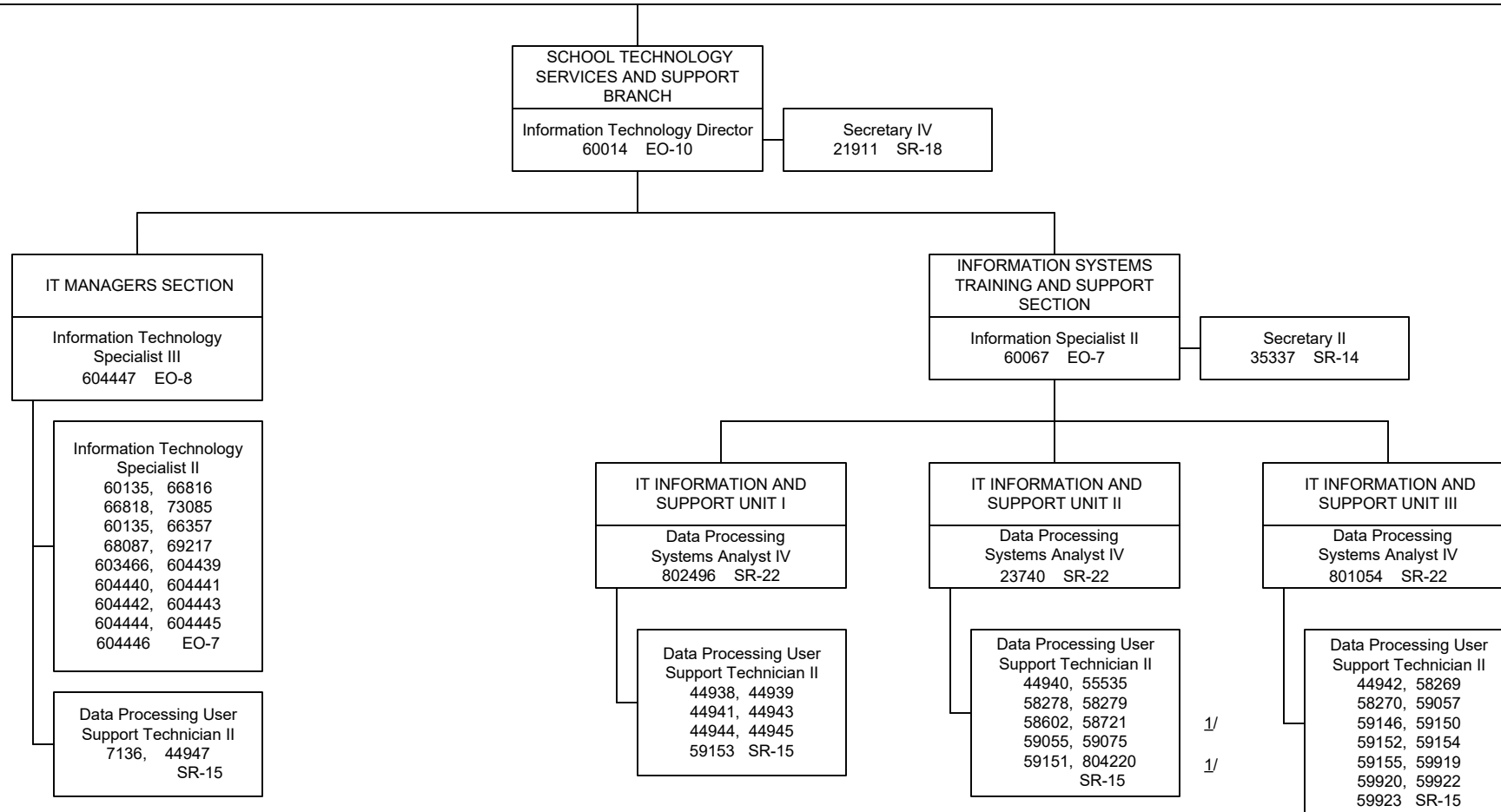

STATE OF HAWAII  
DEPARTMENT OF EDUCATION  
OFFICE OF THE SUPERINTENDENT  
OFFICE OF INFORMATION TECHNOLOGY SERVICES  
ORGANIZATION CHART

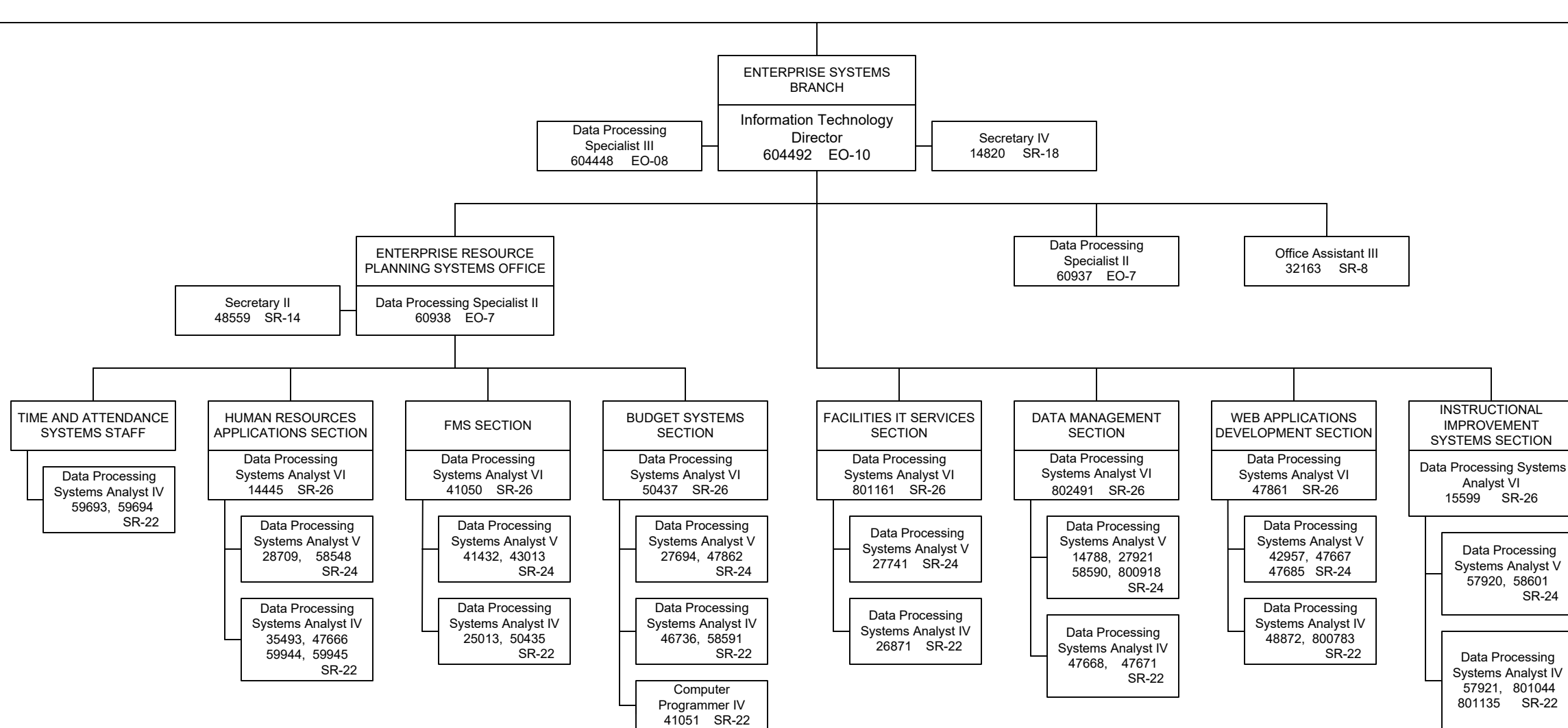

STATE OF HAWAII  
 DEPARTMENT OF EDUCATION  
 OFFICE OF THE SUPERINTENDENT  
 OFFICE OF INFORMATION TECHNOLOGY SERVICES  
 ORGANIZATION CHART

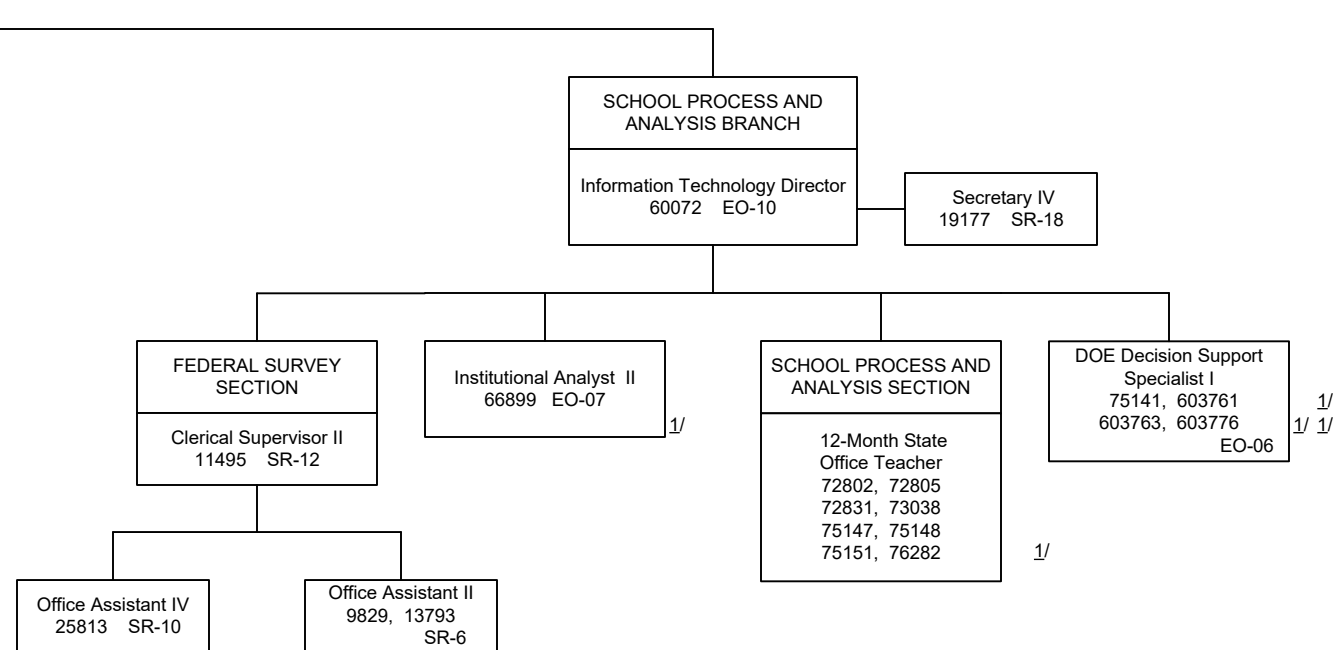

STATE OF HAWAII  
DEPARTMENT OF EDUCATION  
OFFICE OF THE DEPUTY SUPERINTENDENT  
ORGANIZATION CHART

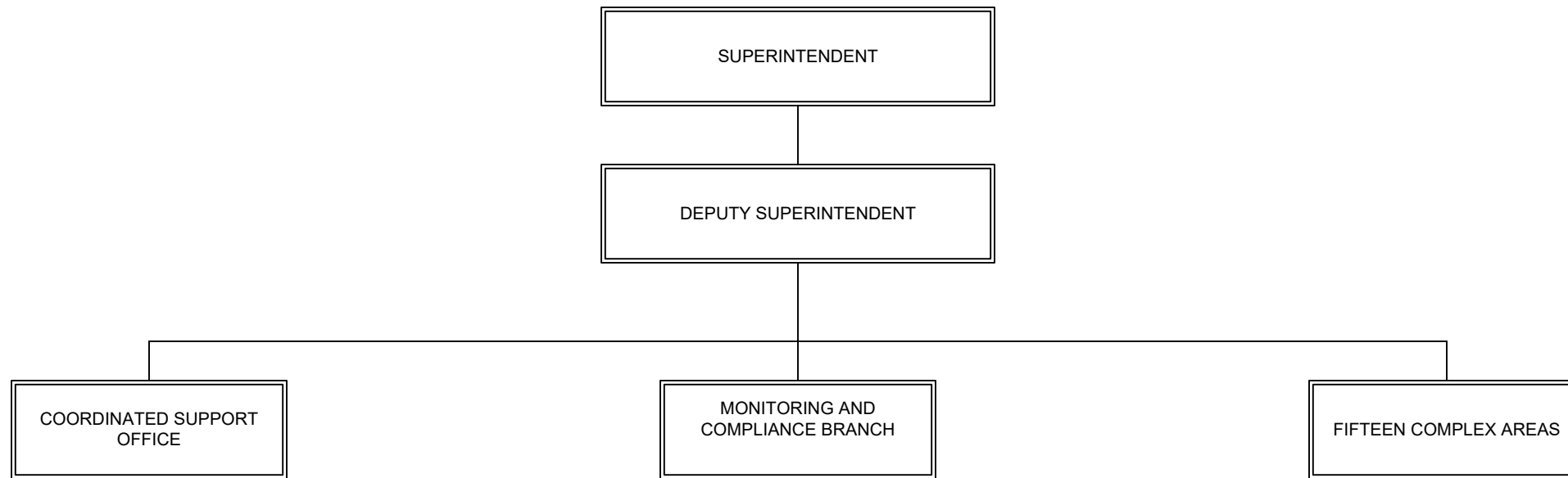

STATE OF HAWAII  
DEPARTMENT OF EDUCATION  
OFFICE OF THE DEPUTY SUPERINTENDENT  
ORGANIZATION CHART

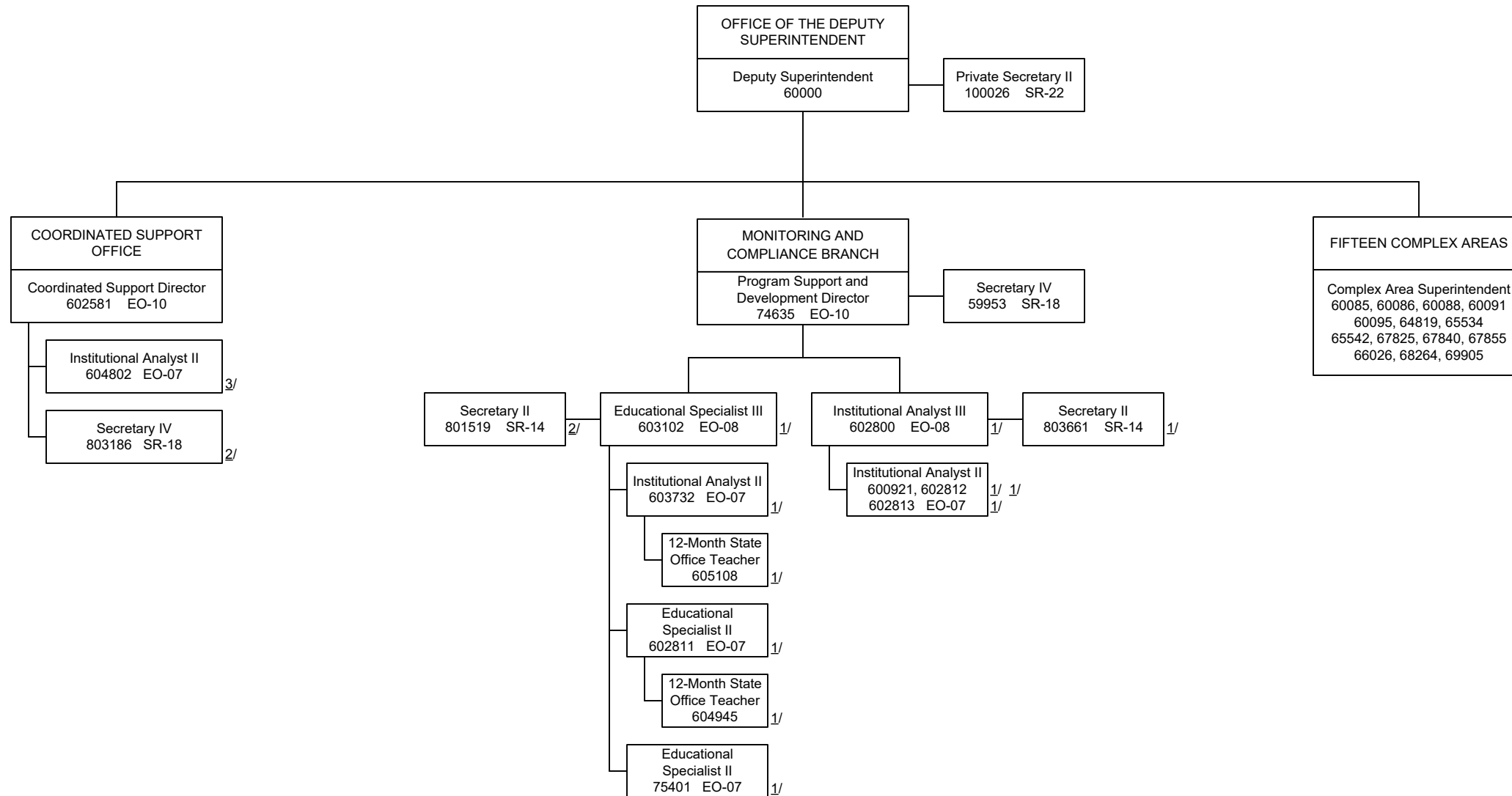

1/ Temporary position, Federal funds  
2/ Temporary position, General funds  
3/ Temporary position, ESSER funds

STATE OF HAWAII  
 DEPARTMENT OF EDUCATION  
 OFFICE OF THE DEPUTY SUPERINTENDENT  
 COMPLEX AREA SUPERINTENDENTS  
 ORGANIZATION CHART

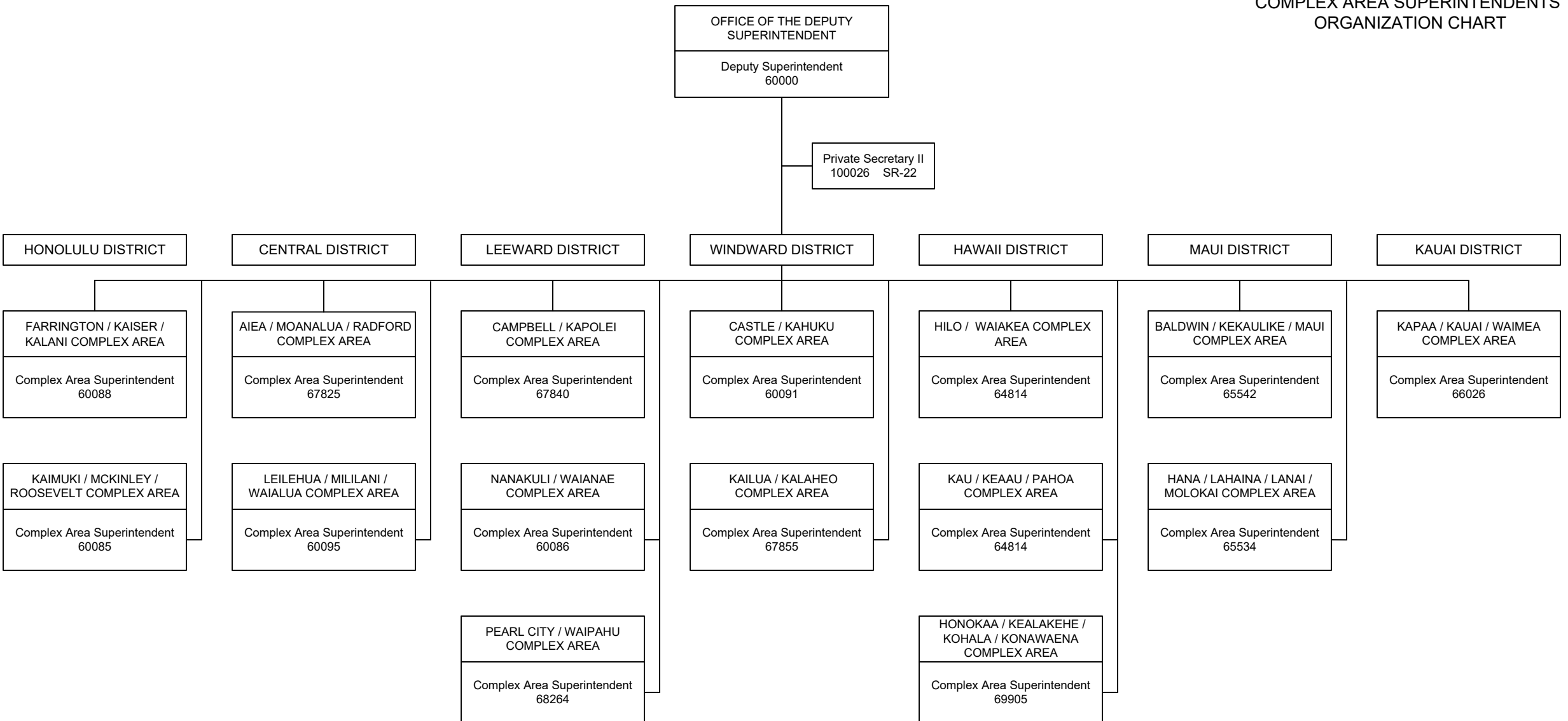

STATE OF HAWAII  
 DEPARTMENT OF EDUCATION  
 OFFICE OF THE DEPUTY SUPERINTENDENT  
 HONOLULU DISTRICT  
 ORGANIZATION CHART

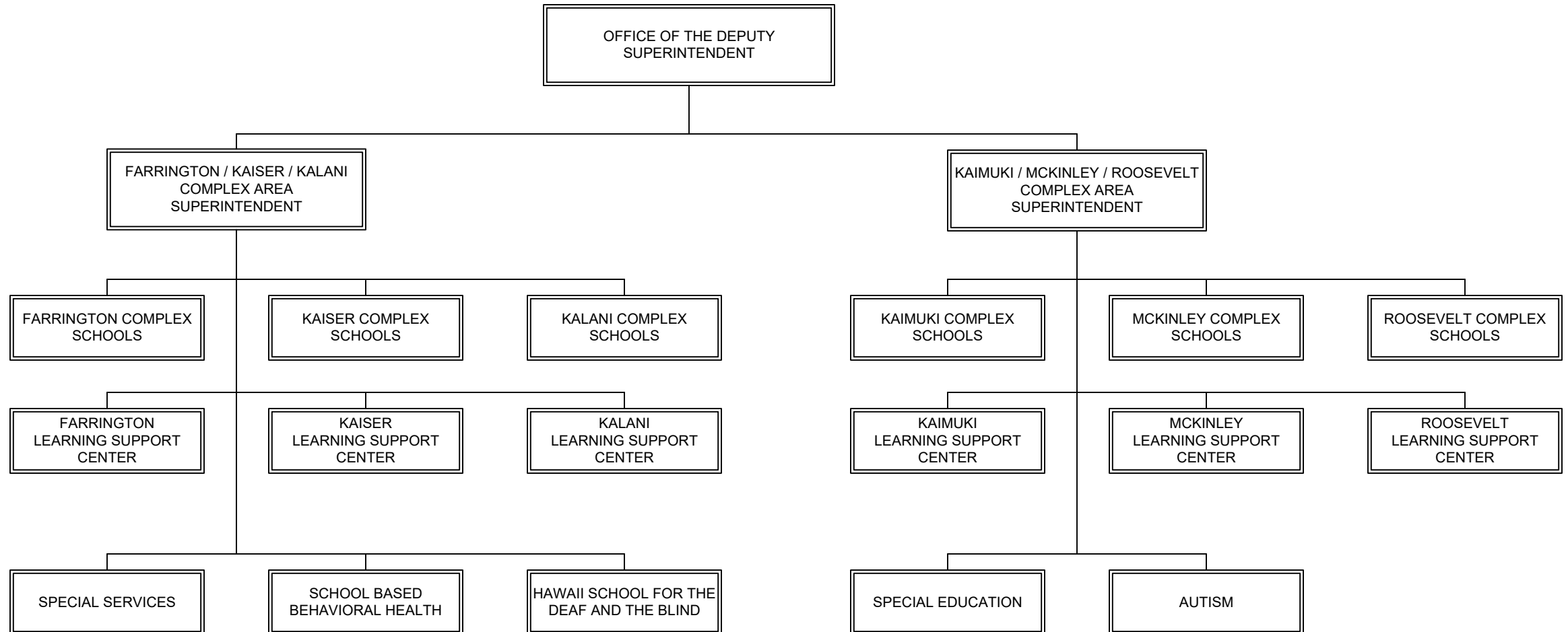

STATE OF HAWAII  
DEPARTMENT OF EDUCATION  
OFFICE OF THE DEPUTY SUPERINTENDENT  
HONOLULU DISTRICT  
ORGANIZATION CHART

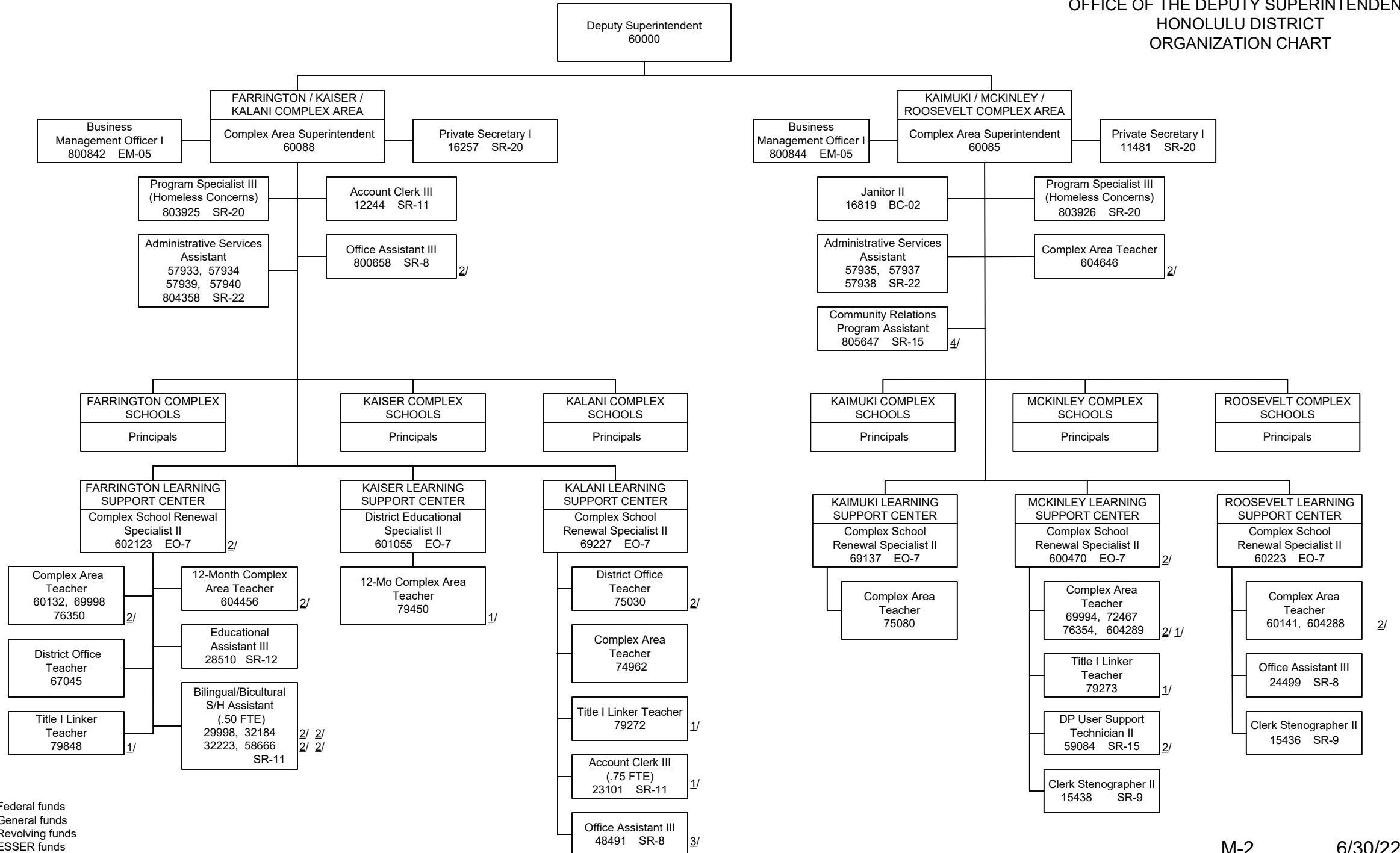

1/ Temporary position, Federal funds  
 2/ Temporary position, General funds  
 3/ Temporary position, Revolving funds  
 4/ Temporary position, ESSER funds



STATE OF HAWAII  
DEPARTMENT OF EDUCATION  
OFFICE OF THE DEPUTY SUPERINTENDENT  
HONOLULU DISTRICT  
ORGANIZATION CHART

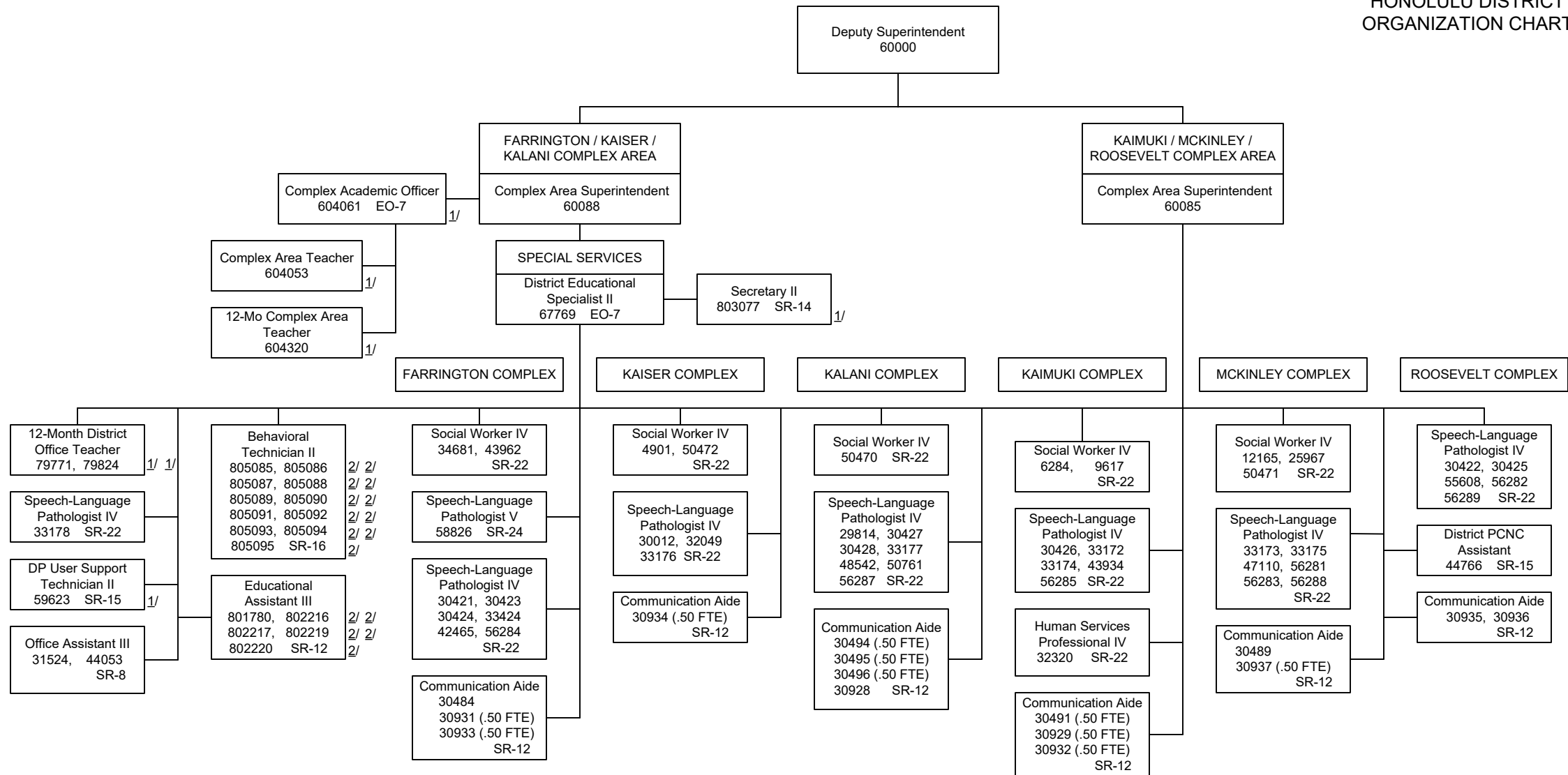

1/ Temporary position, Federal funds  
2/ Temporary position, General funds

STATE OF HAWAII  
DEPARTMENT OF EDUCATION  
OFFICE OF THE DEPUTY SUPERINTENDENT  
HONOLULU DISTRICT  
ORGANIZATION CHART

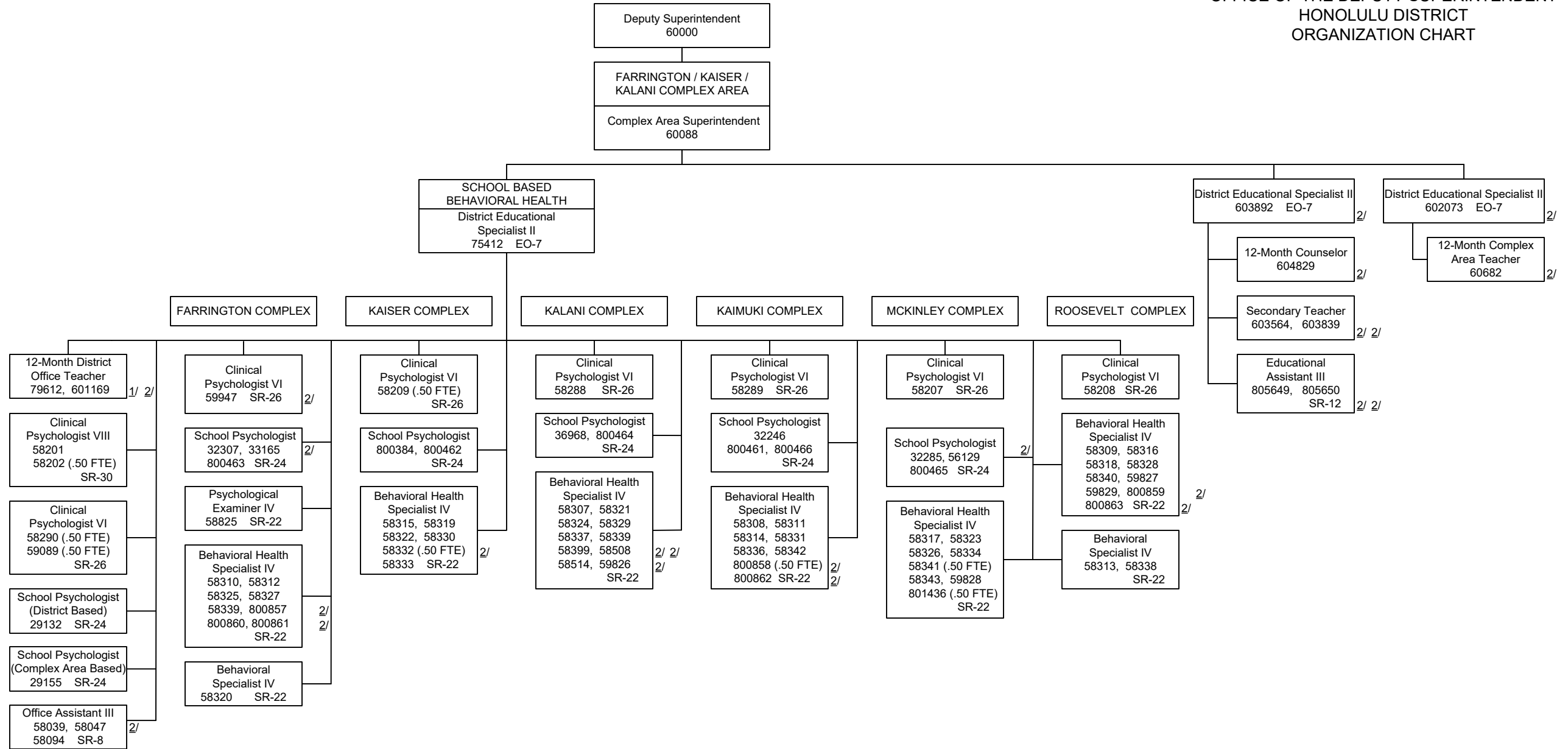

1/ Temporary position, Federal funds  
2/ Temporary position, General funds

STATE OF HAWAII  
DEPARTMENT OF EDUCATION  
OFFICE OF THE DEPUTY SUPERINTENDENT  
HONOLULU DISTRICT  
ORGANIZATION CHART

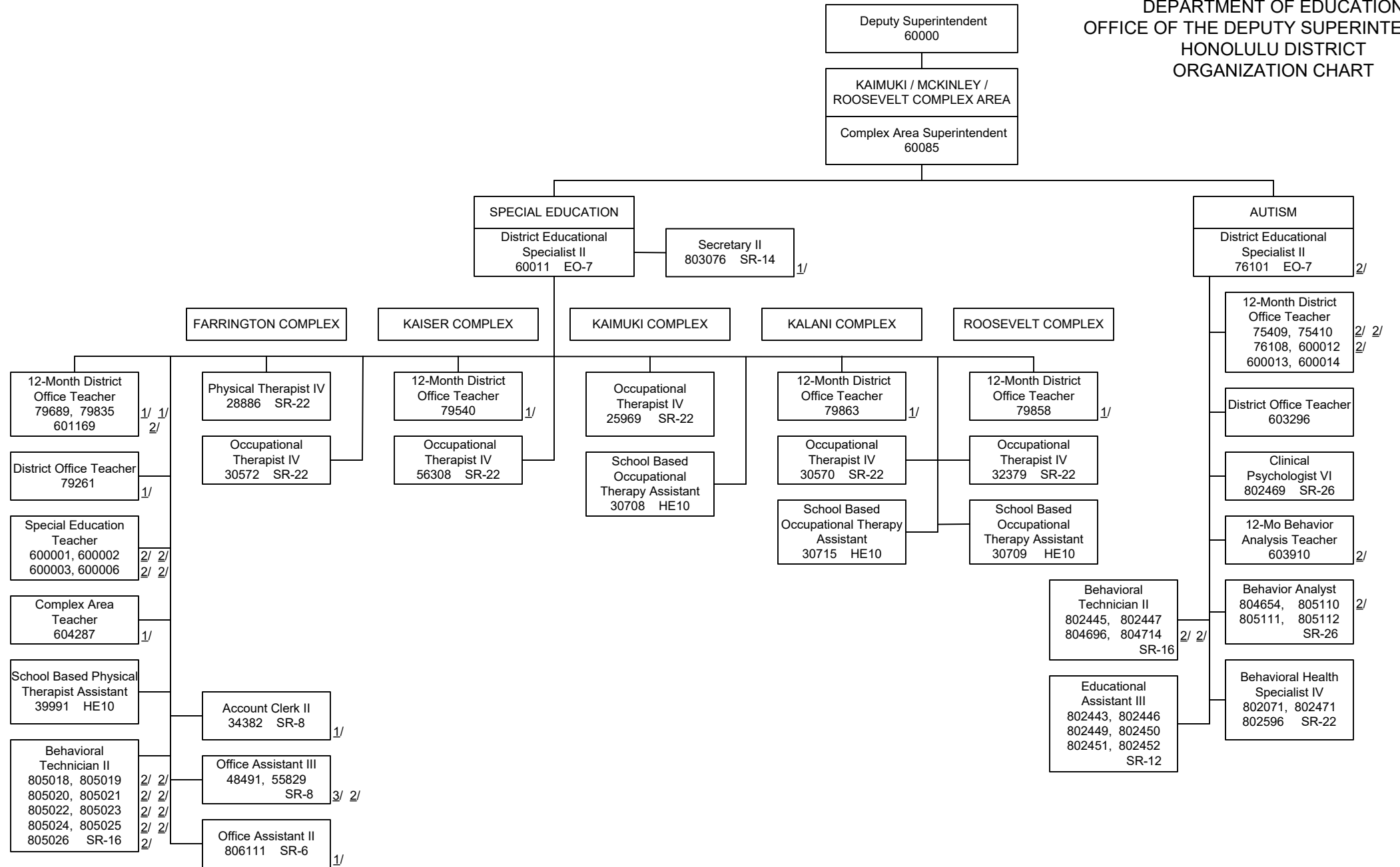

1/ Temporary position, Federal funds  
2/ Temporary position, General funds  
3/ Temporary position, Revolving funds

STATE OF HAWAII  
 OFFICE OF THE DEPUTY SUPERINTENDENT  
 DEPARTMENT OF EDUCATION  
 CENTRAL DISTRICT  
 ORGANIZATION CHART

OFFICE OF THE DEPUTY SUPERINTENDENT

AIEA / MOANALUA / RADFORD  
 COMPLEX AREA  
 SUPERINTENDENT

LEILEHUA / MILILANI / WAIALUA  
 COMPLEX AREA  
 SUPERINTENDENT

AIEA COMPLEX  
 SCHOOLS

MOANALUA COMPLEX  
 SCHOOLS

RADFORD COMPLEX  
 SCHOOLS

LEILEHUA COMPLEX  
 SCHOOLS

MILILANI COMPLEX  
 SCHOOLS

WAIALUA COMPLEX  
 SCHOOLS

AIEA  
 LEARNING SUPPORT CENTER

MOANALUA  
 LEARNING SUPPORT CENTER

RADFORD  
 LEARNING SUPPORT CENTER

LEILEHUA  
 LEARNING SUPPORT CENTER

MILILANI  
 LEARNING SUPPORT CENTER

WAIALUA  
 LEARNING SUPPORT CENTER

STUDENT SUPPORT  
 SERVICES  
 AIEA / MOANALUA / RADFORD

STUDENT SUPPORT  
 SERVICES LEILEHUA /  
 MILILANI / WAIALUA

SCHOOL BASED  
 BEHAVIORAL HEALTH

AUTISM

STATE OF HAWAII  
 OFFICE OF THE DEPUTY SUPERINTENDENT  
 DEPARTMENT OF EDUCATION  
 CENTRAL DISTRICT  
 ORGANIZATION CHART

Deputy Superintendent  
60000

AIEA / MOANALUA /  
RADFORD COMPLEX AREA  
 Complex Area Superintendent  
67825  
 Private Secretary I  
21919 SR-20

LEILEHUA / MILILANI /  
WAIALUA COMPLEX AREA  
 Complex Area Superintendent  
60095  
 Private Secretary I  
12263 SR-20

District Educational Specialist II  
604590 EO-7 1/

Complex Academic Officer  
604871 EO-7 2/

Account Clerk IV  
15434 SR-13

Administrative Services Assistant  
57944, 804223 SR-22 2/

Business Management Officer I  
800805 EM-05

Complex Area Personnel Specialist II  
603958 EO-7

Program Specialist III (Homeless Concerns)  
803913 SR-20

Office Assistant III  
30546 SR-8

District Educational Specialist II  
76347 EO-7 2/

Business Management Officer I  
800806 EM-05

Program Specialist III (Homeless Concerns)  
803914 SR-20

Administrative Services Assistant  
57943, 57946, 57947 SR-22

Complex Academic Officer  
602273, 604876 EO-7 2/ 2/

Complex Area Personnel Specialist II  
601086 EO-7 2/

12-Month District Office Teacher  
603827 2/

District Office Teacher  
603865, 603866 2/ 2/

Office Assistant IV  
35675 SR-10

Community Relations Program Assistant  
806094 SR-15 3/

Office Assistant IV (0.5 FTE)  
804541 SR-8 2/

AIEA COMPLEX SCHOOLS  
Principals

MOANALUA COMPLEX SCHOOLS  
Principals

RADFORD COMPLEX SCHOOLS  
Principals

LEILEHUA COMPLEX SCHOOLS  
Principals

MILILANI COMPLEX SCHOOLS  
Principals

WAIALUA COMPLEX SCHOOLS  
Principals

AIEA LEARNING SUPPORT CENTER  
Complex School Renewal Specialist II  
67829 EO-7

MOANALUA LEARNING SUPPORT CENTER  
Complex School Renewal Specialist II  
60084 EO-7

RADFORD LEARNING SUPPORT CENTER  
Complex School Renewal Specialist II  
60087 EO-7

District Office Teacher  
62346

Title I Linker Teacher  
79276 1/

12-Month District Office Teacher  
79451 1/

Bilingual/Bicultural School-Home Assistant  
805297, 805313 SR-11 2/ 2/

District Office Teacher  
600468 1/

District Office Teacher  
72740 2/

12-Month Complex Area Teacher  
602523 2/

LEILEHUA LEARNING SUPPORT CENTER  
Complex School Renewal Specialist II  
60036 EO-7

MILILANI / WAIALUA LEARNING SUPPORT CENTER  
Complex School Renewal Specialist II  
68505 EO-7

District Educational Specialist II  
604066 EO-7 1/

Title I Linker Teacher  
79849 1/

CSSS Resource Teacher  
600469 2/

12-Mo Complex Area Teacher  
602524 2/

Complex Area Teacher  
62385, 63190 2/

Bilingual/Bicultural S/H Assistant  
29991 40229 (.50 FTE) SR-11 2/ 2/

District Office Teacher  
79432 1/

CSSS Resource Teacher  
75082

12-Mo District Office Teacher  
603298 1/

Office Assistant III  
15433 SR-8

1/ Temporary position, Federal funds  
 2/ Temporary position, General funds  
 3/ Temporary position, ESSER funds

STATE OF HAWAII  
OFFICE OF THE DEPUTY SUPERINTENDENT  
DEPARTMENT OF EDUCATION  
CENTRAL DISTRICT  
ORGANIZATION CHART

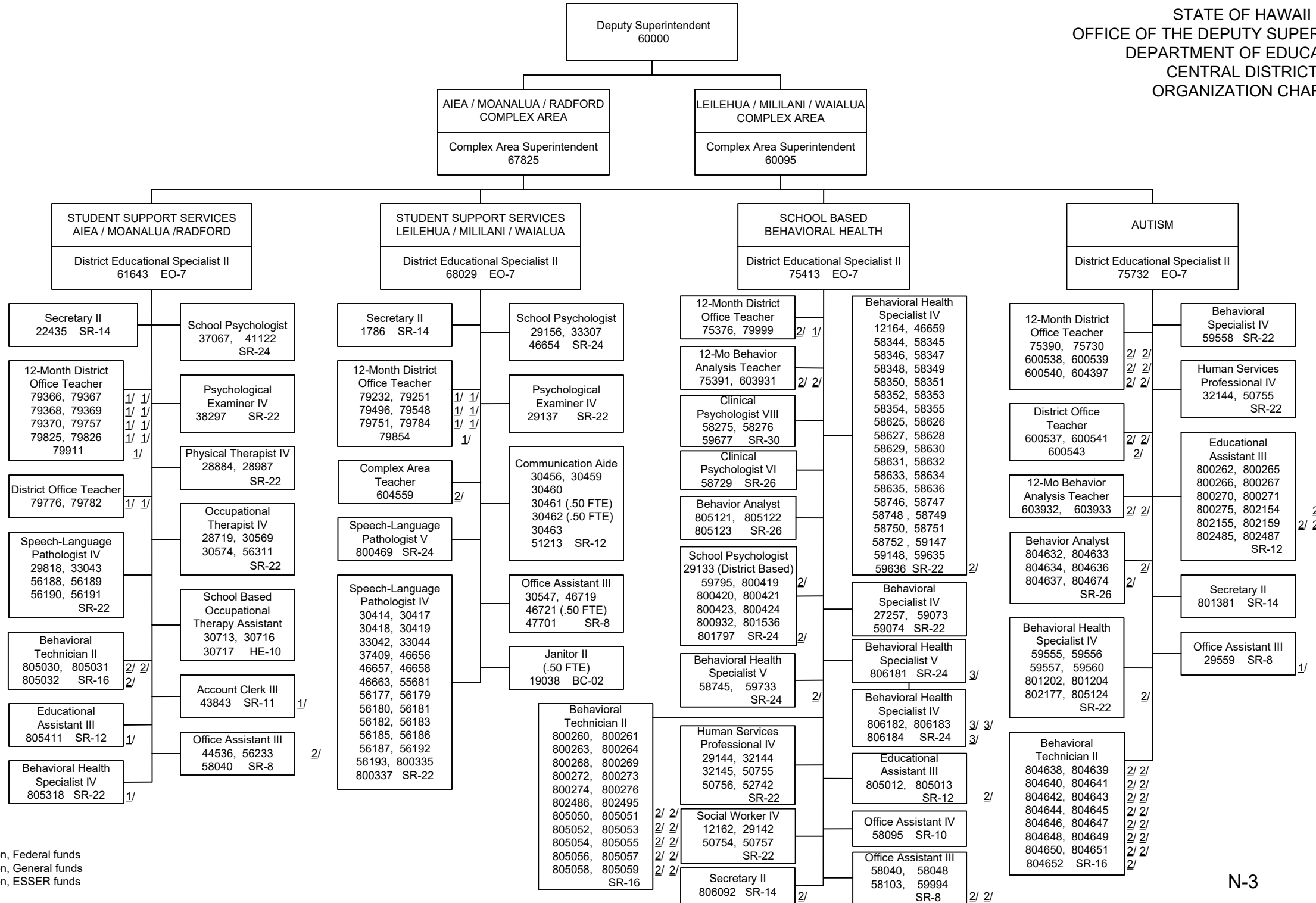

1/ Temporary position, Federal funds  
 2/ Temporary position, General funds  
 3/ Temporary position, ESSER funds

STATE OF HAWAII  
 DEPARTMENT OF EDUCATION  
 OFFICE OF THE DEPUTY SUPERINTENDENT  
 LEEWARD DISTRICT  
 ORGANIZATION CHART

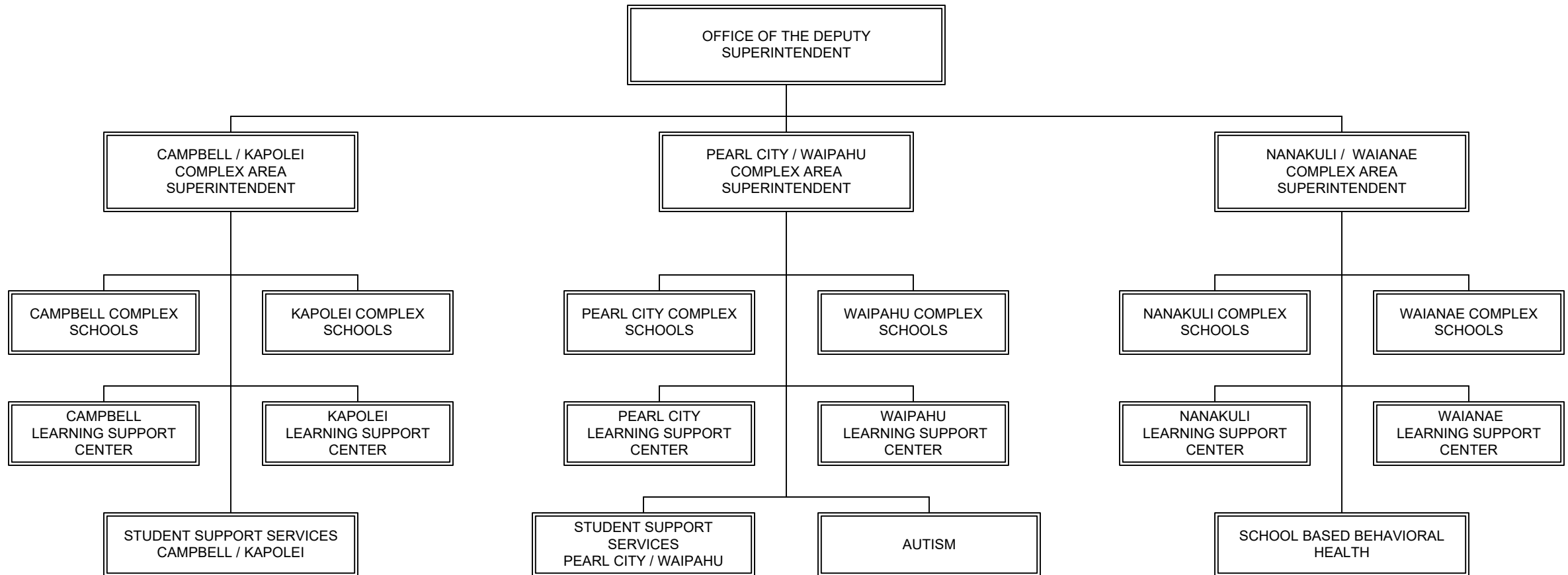

STATE OF HAWAII  
DEPARTMENT OF EDUCATION  
OFFICE OF THE DEPUTY SUPERINTENDENT  
LEEWARD DISTRICT  
ORGANIZATION CHART

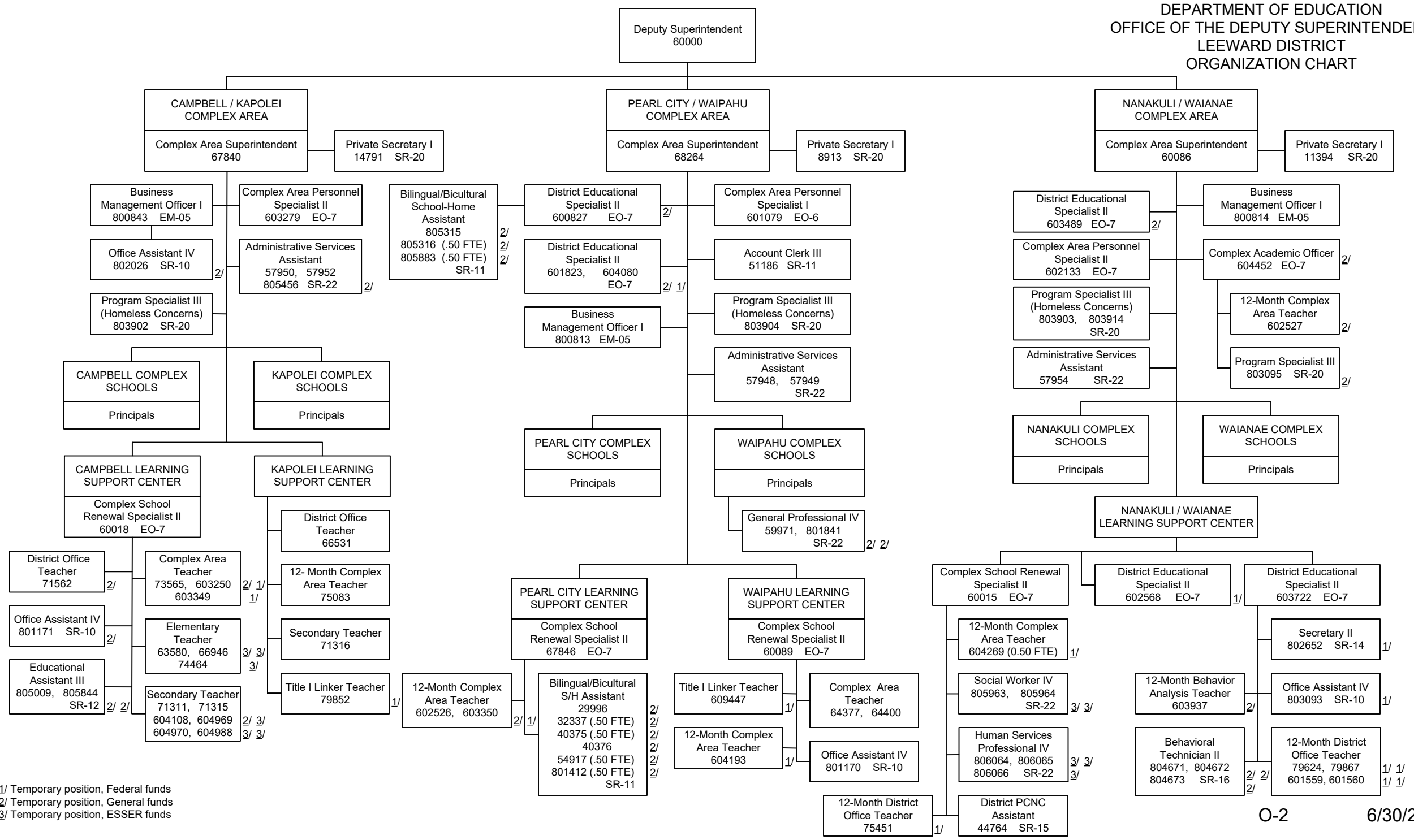

1/ Temporary position, Federal funds  
2/ Temporary position, General funds  
3/ Temporary position, ESSER funds



STATE OF HAWAII  
DEPARTMENT OF EDUCATION  
OFFICE OF THE DEPUTY SUPERINTENDENT  
LEEWARD DISTRICT  
ORGANIZATION CHART

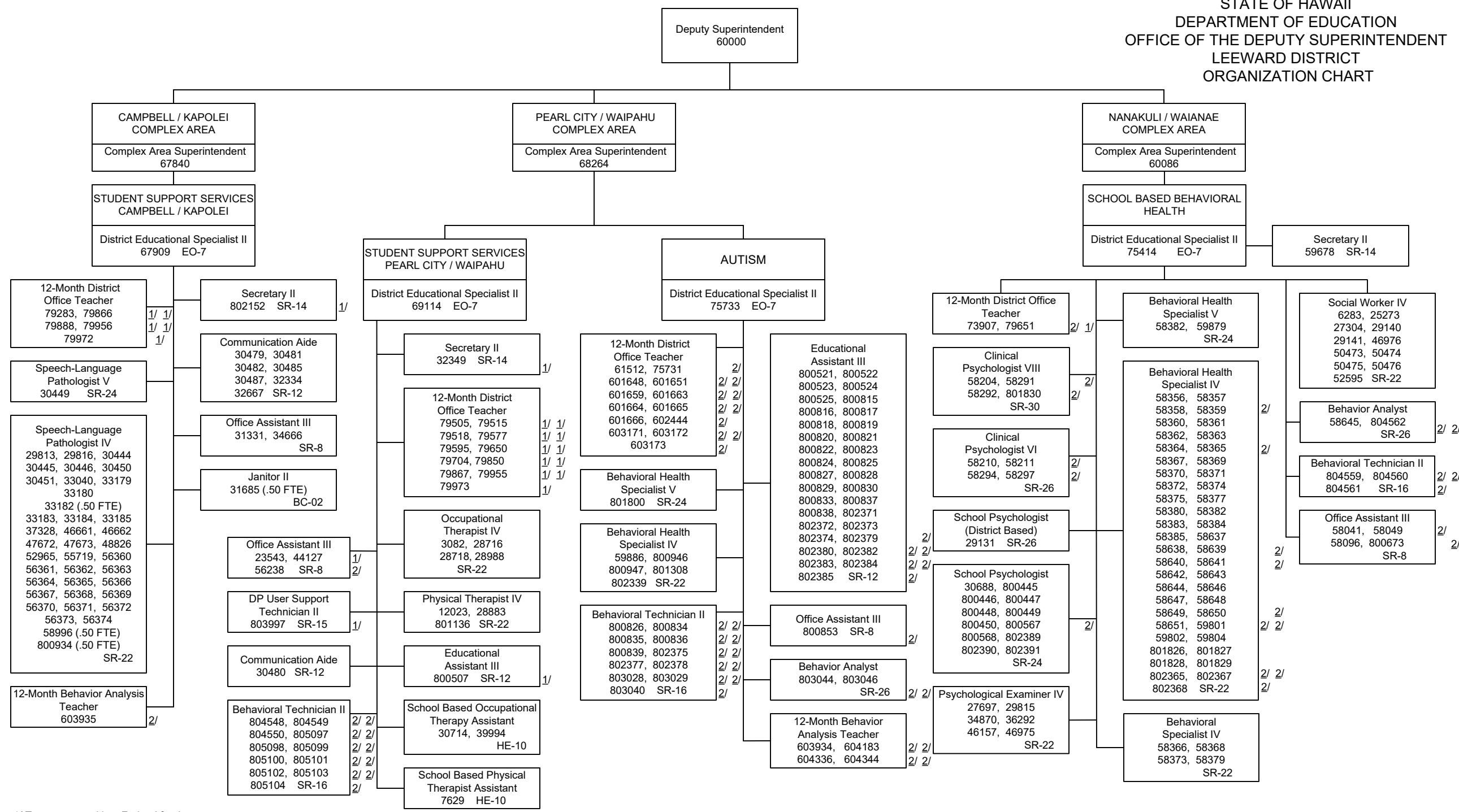

1/ Temporary position, Federal funds  
2/ Temporary position, General funds

STATE OF HAWAII  
DEPARTMENT OF EDUCATION  
OFFICE OF THE DEPUTY SUPERINTENDENT  
WINDWARD DISTRICT  
ORGANIZATION CHART

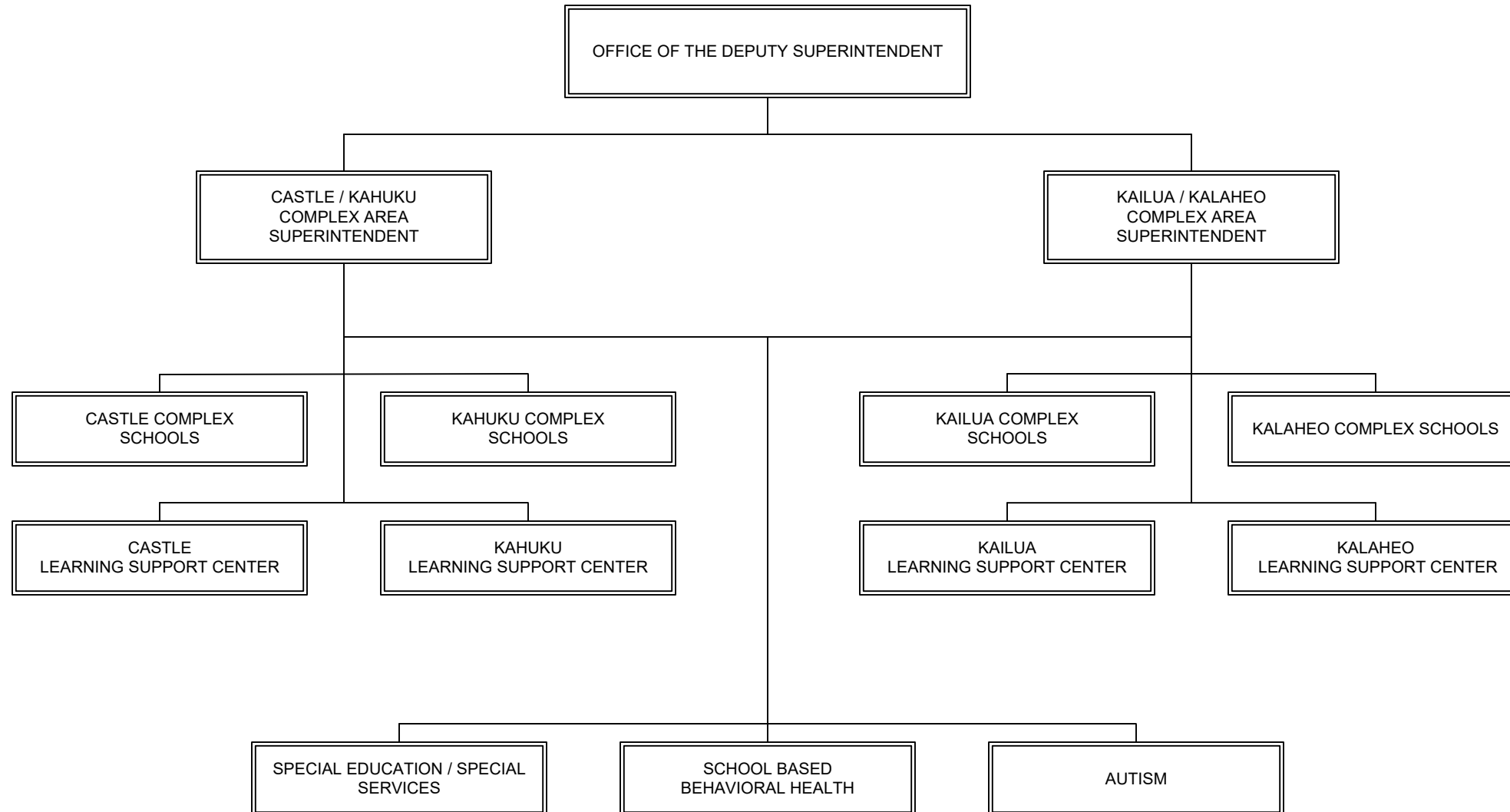

STATE OF HAWAII  
DEPARTMENT OF EDUCATION  
OFFICE OF THE DEPUTY SUPERINTENDENT  
WINDWARD DISTRICT  
ORGANIZATION CHART

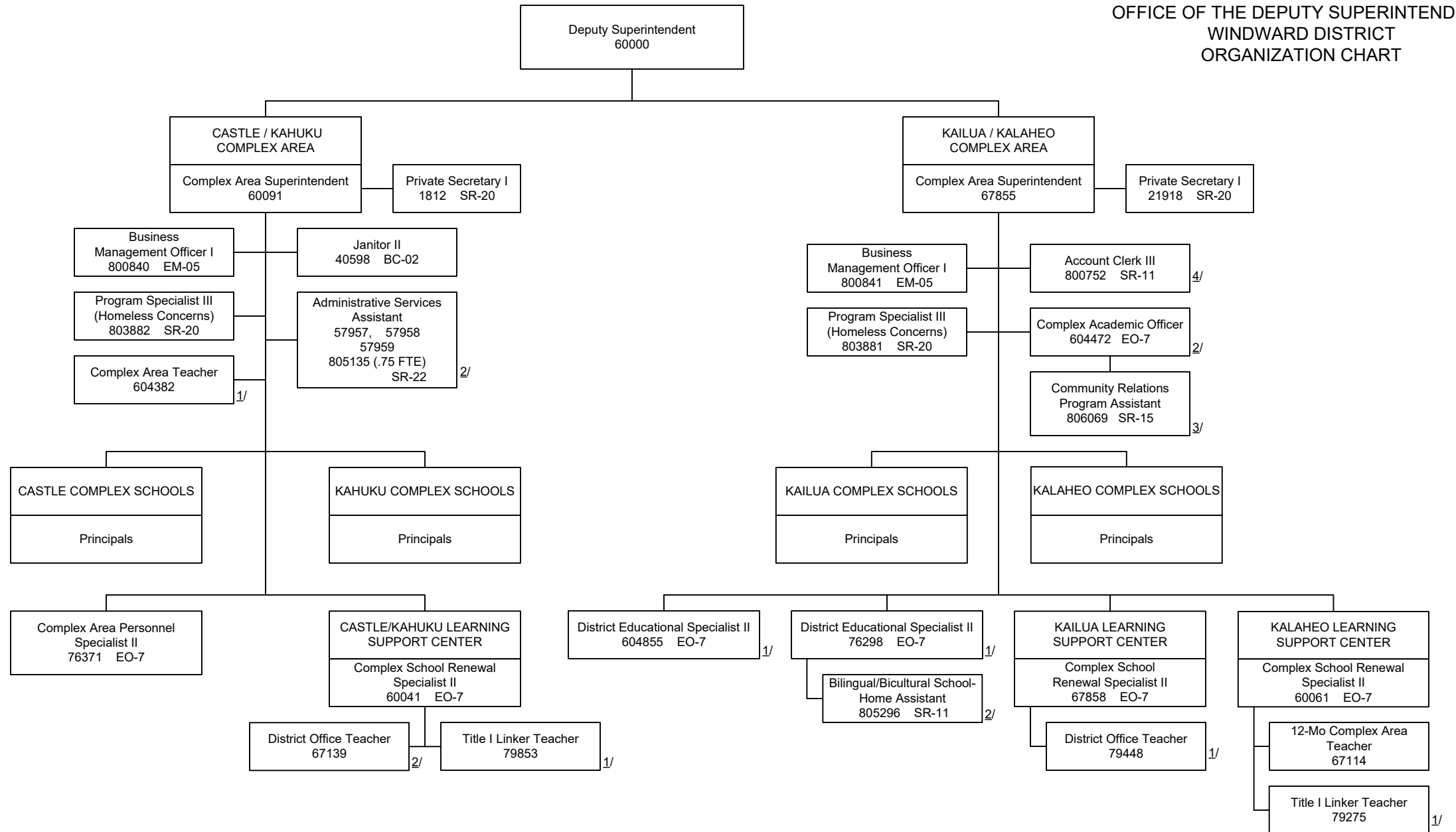

1/ Temporary position, Federal funds  
2/ Temporary position, General funds  
3/ Temporary position, Trust funds  
4/ Temporary position, Revolving funds

STATE OF HAWAII  
DEPARTMENT OF EDUCATION  
OFFICE OF THE DEPUTY SUPERINTENDENT  
WINDWARD DISTRICT  
ORGANIZATION CHART

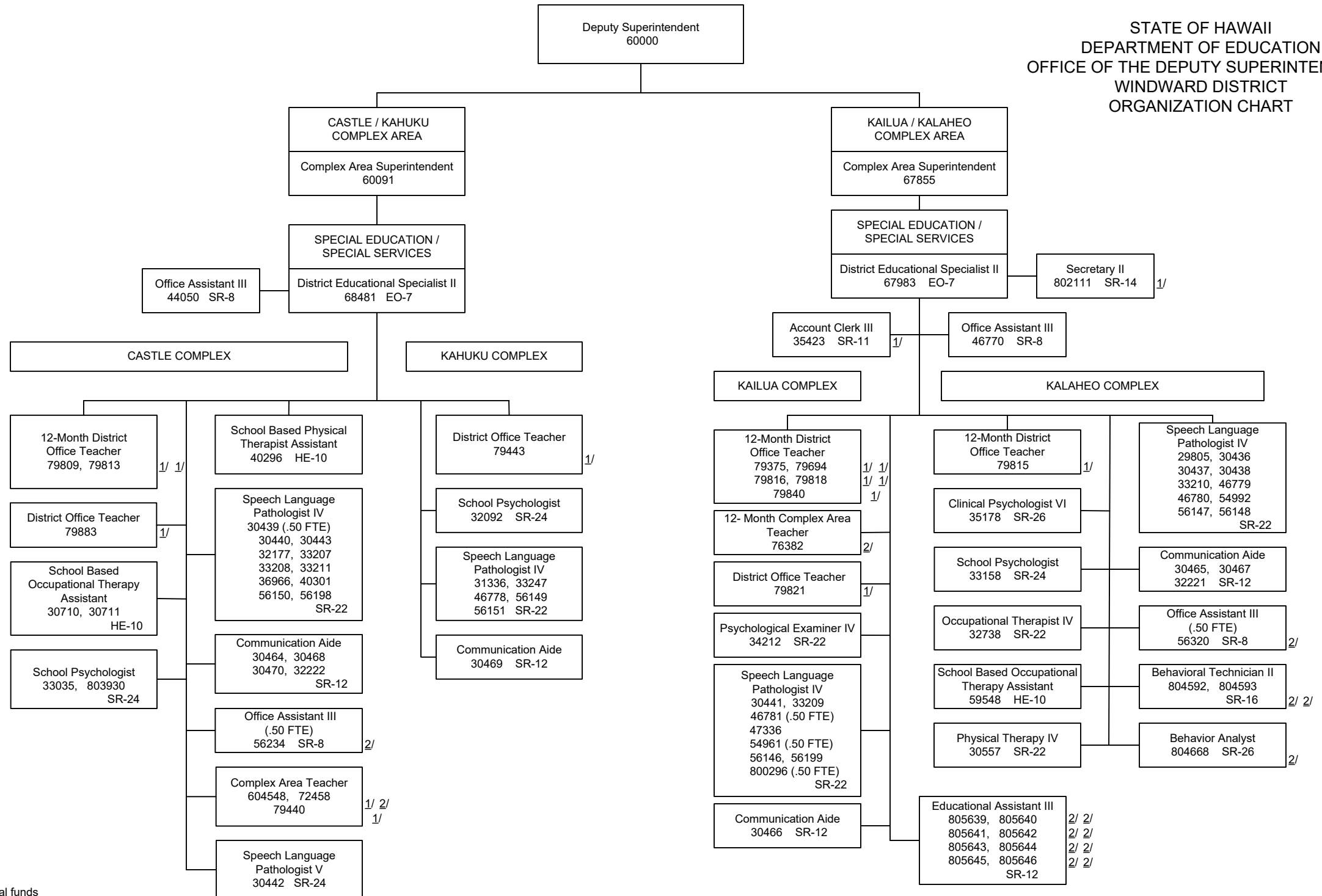

1/ Temporary position, Federal funds  
2/ Temporary position, General funds

STATE OF HAWAII  
DEPARTMENT OF EDUCATION  
OFFICE OF THE DEPUTY SUPERINTENDENT  
WINDWARD DISTRICT  
ORGANIZATION CHART

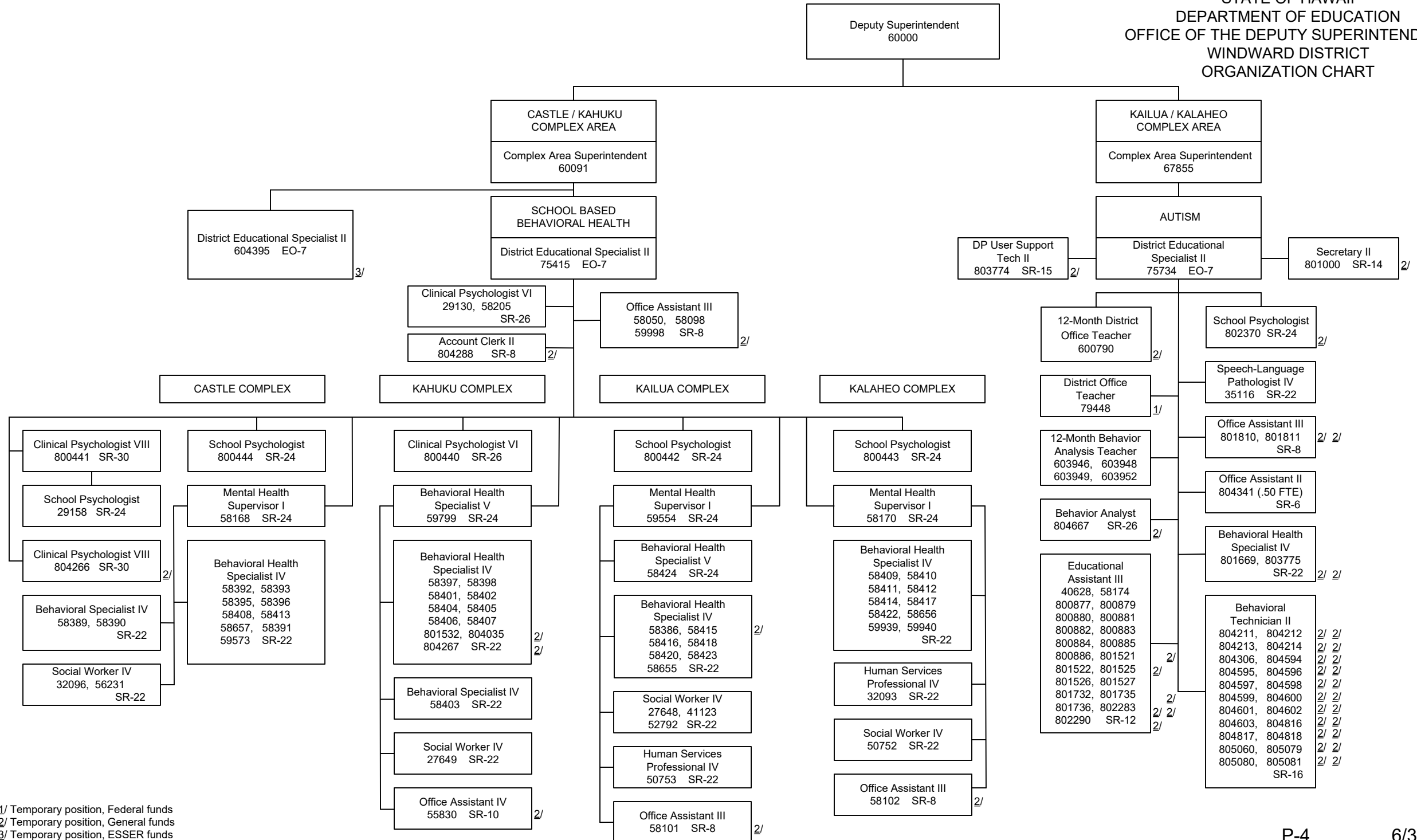

1/ Temporary position, Federal funds  
2/ Temporary position, General funds  
3/ Temporary position, ESSER funds

STATE OF HAWAII  
 DEPARTMENT OF EDUCATION  
 OFFICE OF THE DEPUTY SUPERINTENDENT  
 HAWAII DISTRICT  
 ORGANIZATION CHART

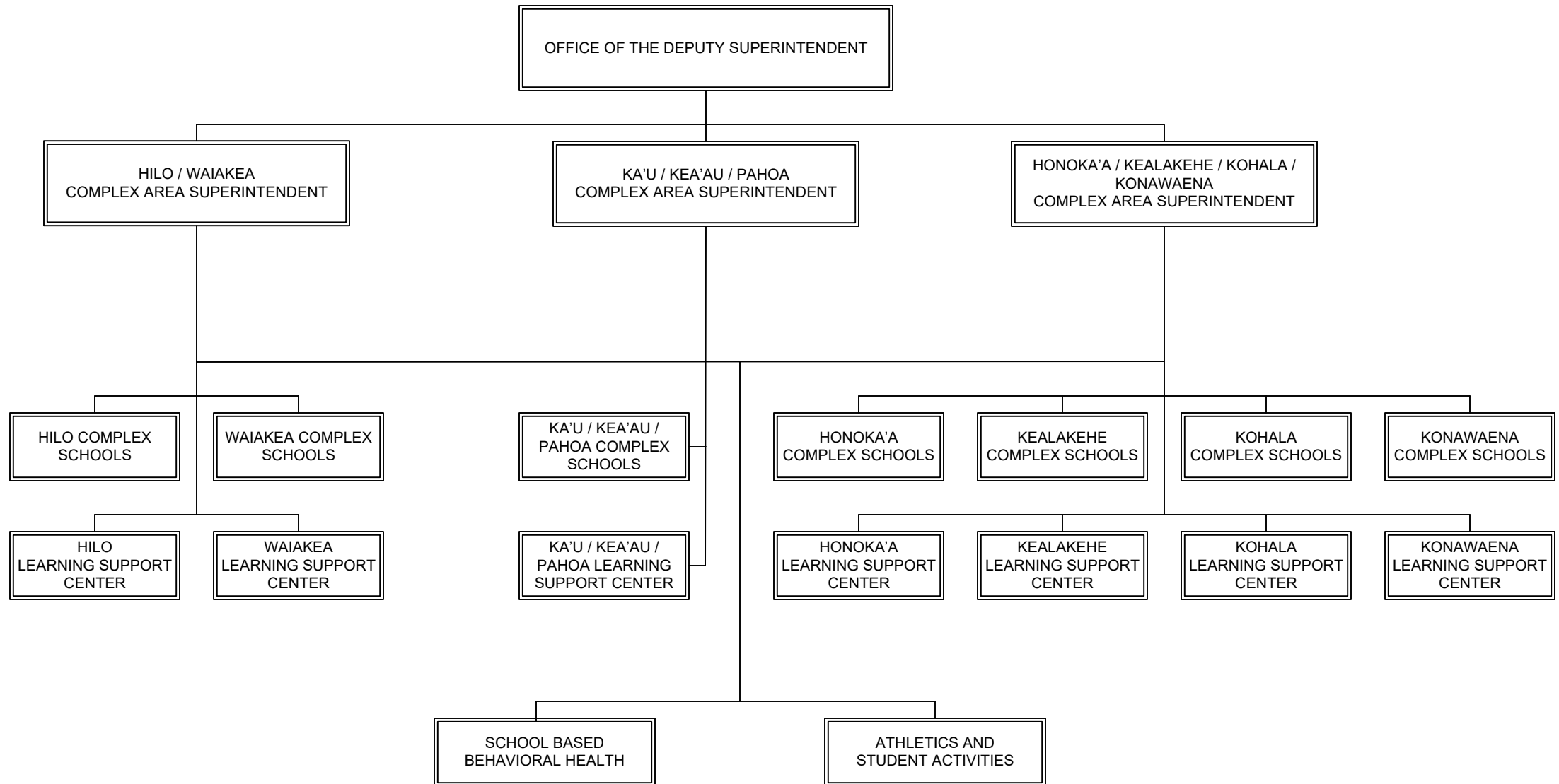

STATE OF HAWAII  
DEPARTMENT OF EDUCATION  
OFFICE OF THE DEPUTY SUPERINTENDENT  
HAWAII DISTRICT  
ORGANIZATION CHART

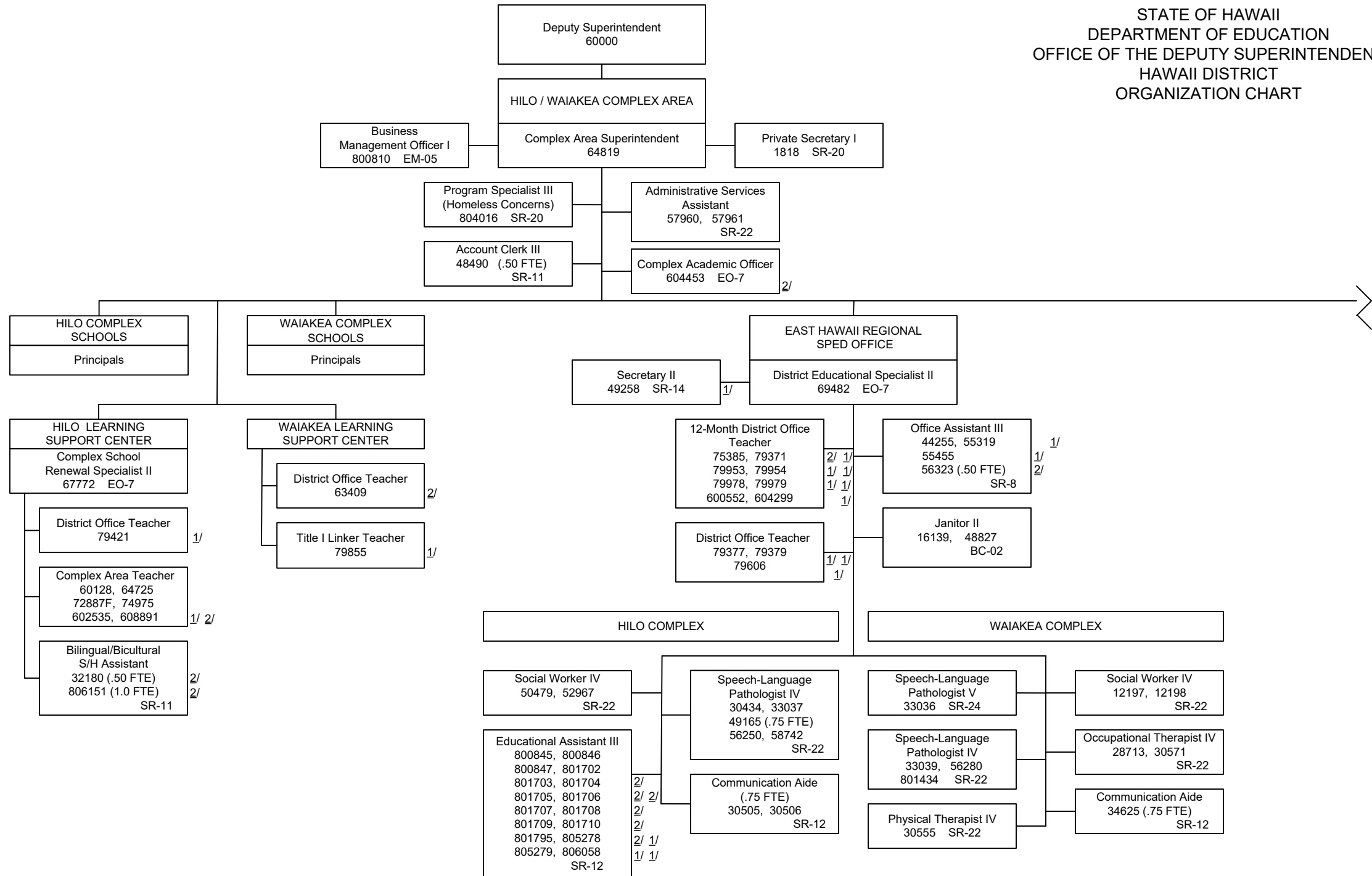

1/ Temporary position, Federal funds  
2/ Temporary position, General funds

HILO / WAIAKEA COMPLEX AREA

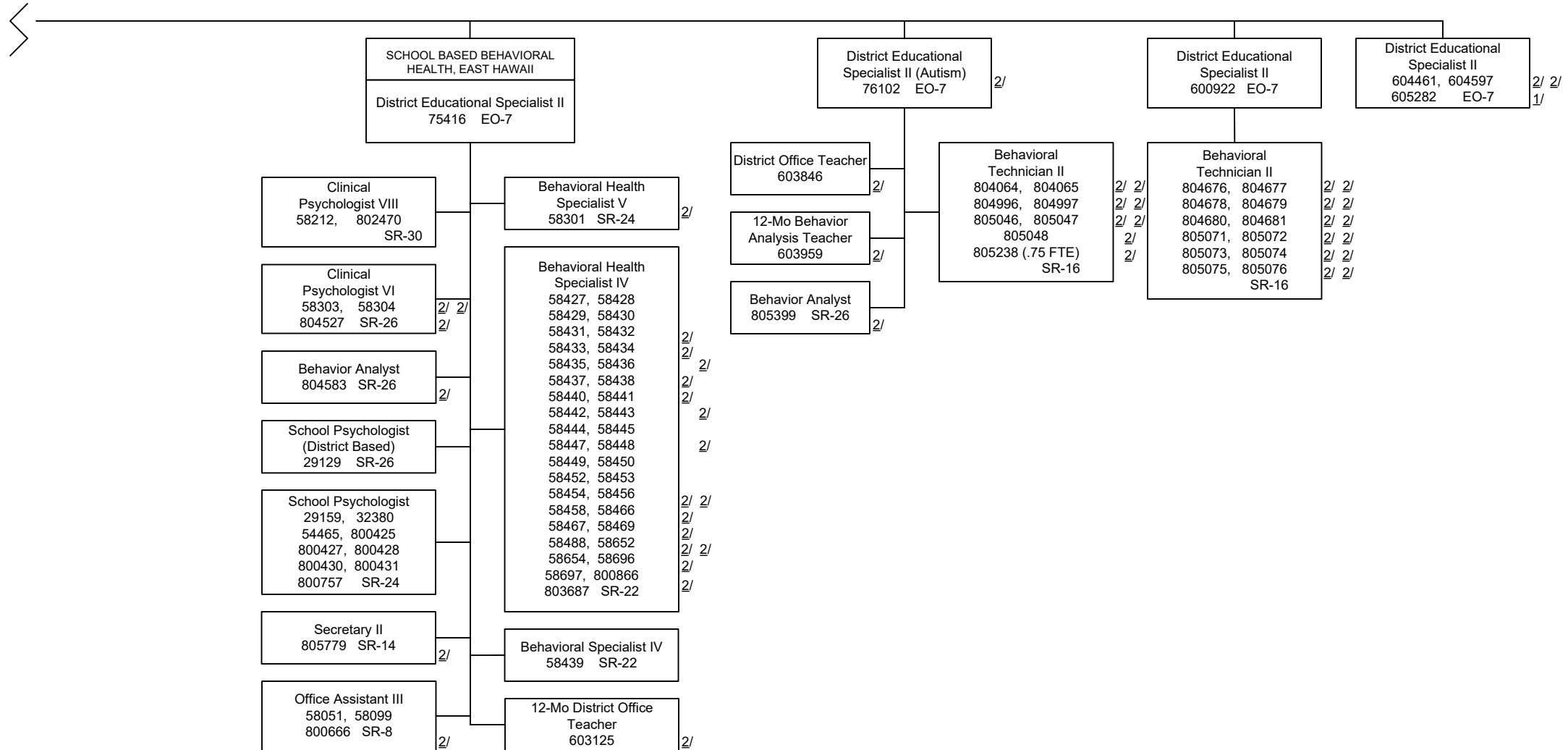

1/ Temporary position, Federal funds  
2/ Temporary position, General funds



STATE OF HAWAII  
DEPARTMENT OF EDUCATION  
OFFICE OF THE DEPUTY SUPERINTENDENT  
HAWAII DISTRICT  
ORGANIZATION CHART

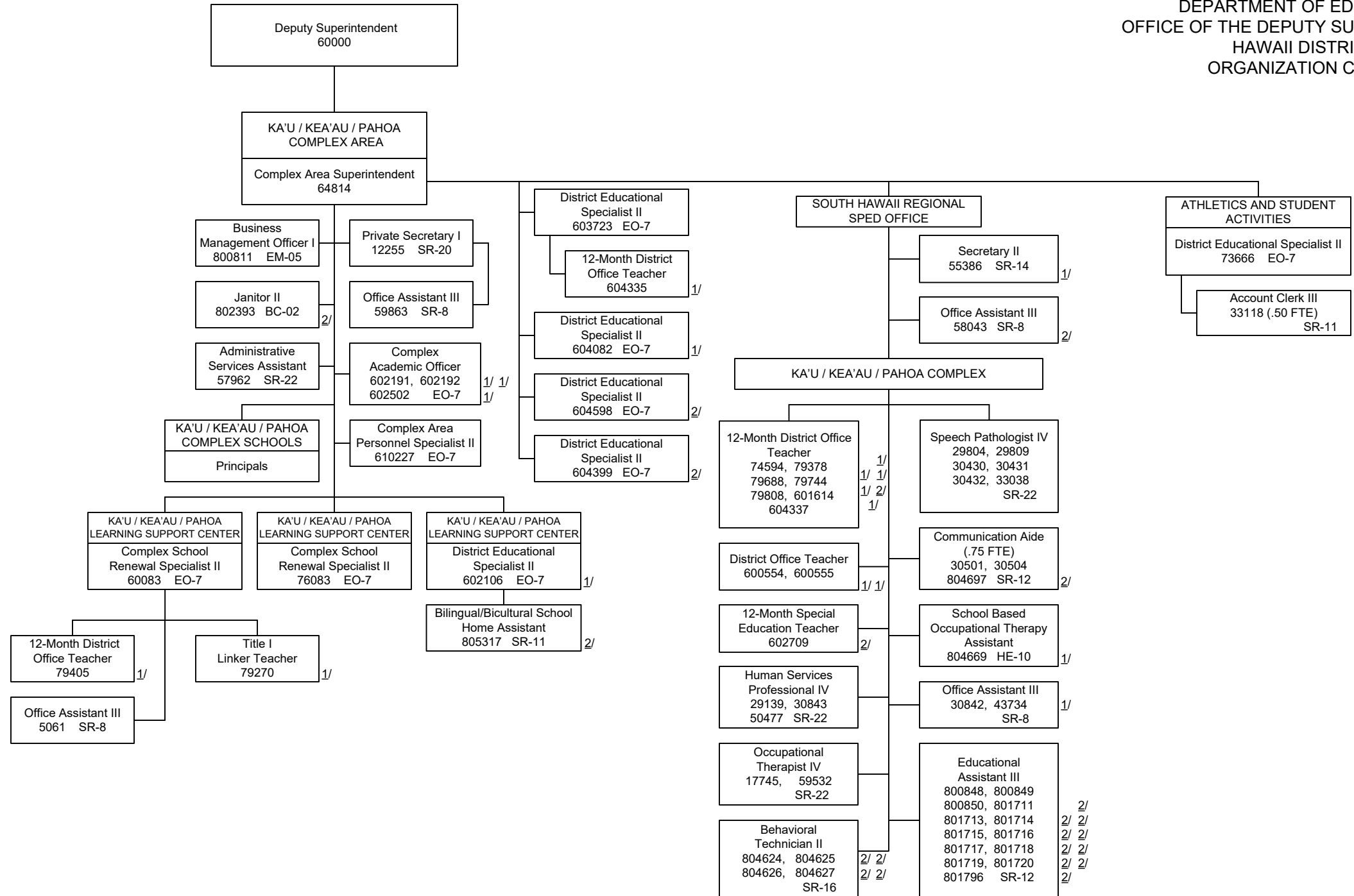

1/ Temporary position, Federal funds  
2/ Temporary position, General funds

STATE OF HAWAII  
DEPARTMENT OF EDUCATION  
OFFICE OF THE DEPUTY SUPERINTENDENT  
HAWAII DISTRICT  
ORGANIZATION CHART

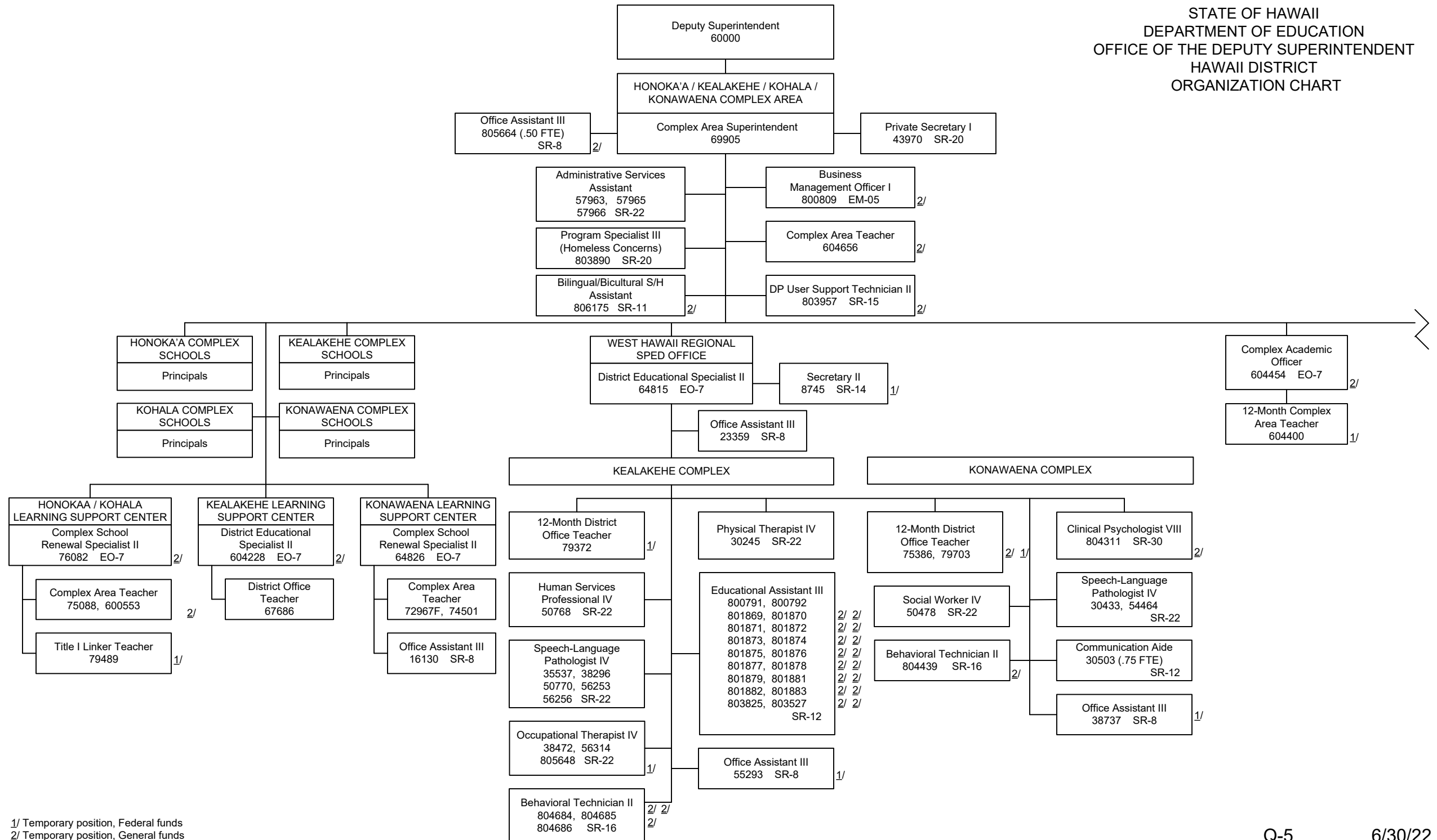

1/ Temporary position, Federal funds  
2/ Temporary position, General funds

STATE OF HAWAII  
DEPARTMENT OF EDUCATION  
OFFICE OF THE DEPUTY SUPERINTENDENT  
HAWAII DISTRICT  
ORGANIZATION CHART

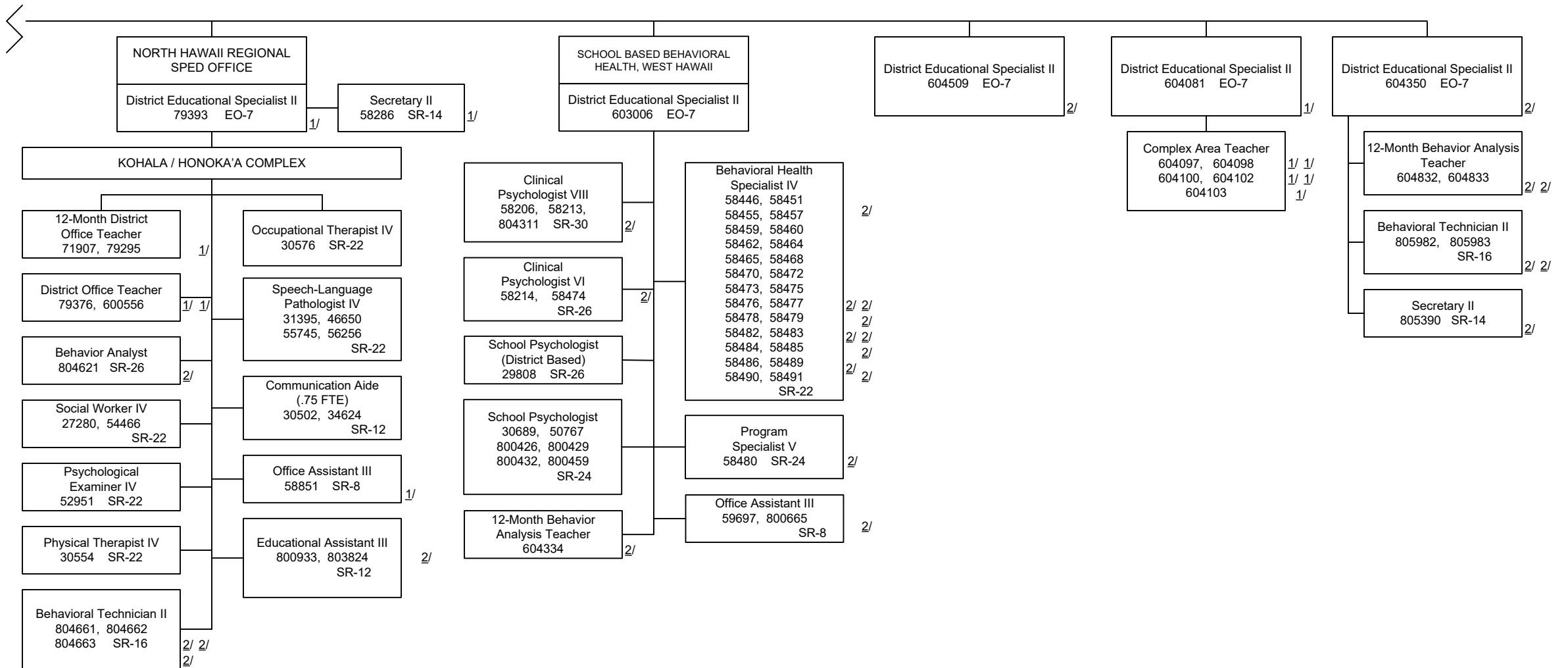

1/ Temporary position, Federal funds  
2/ Temporary position, General funds

STATE OF HAWAII  
DEPARTMENT OF EDUCATION  
OFFICE OF THE DEPUTY SUPERINTENDENT  
MAUI DISTRICT  
ORGANIZATION CHART

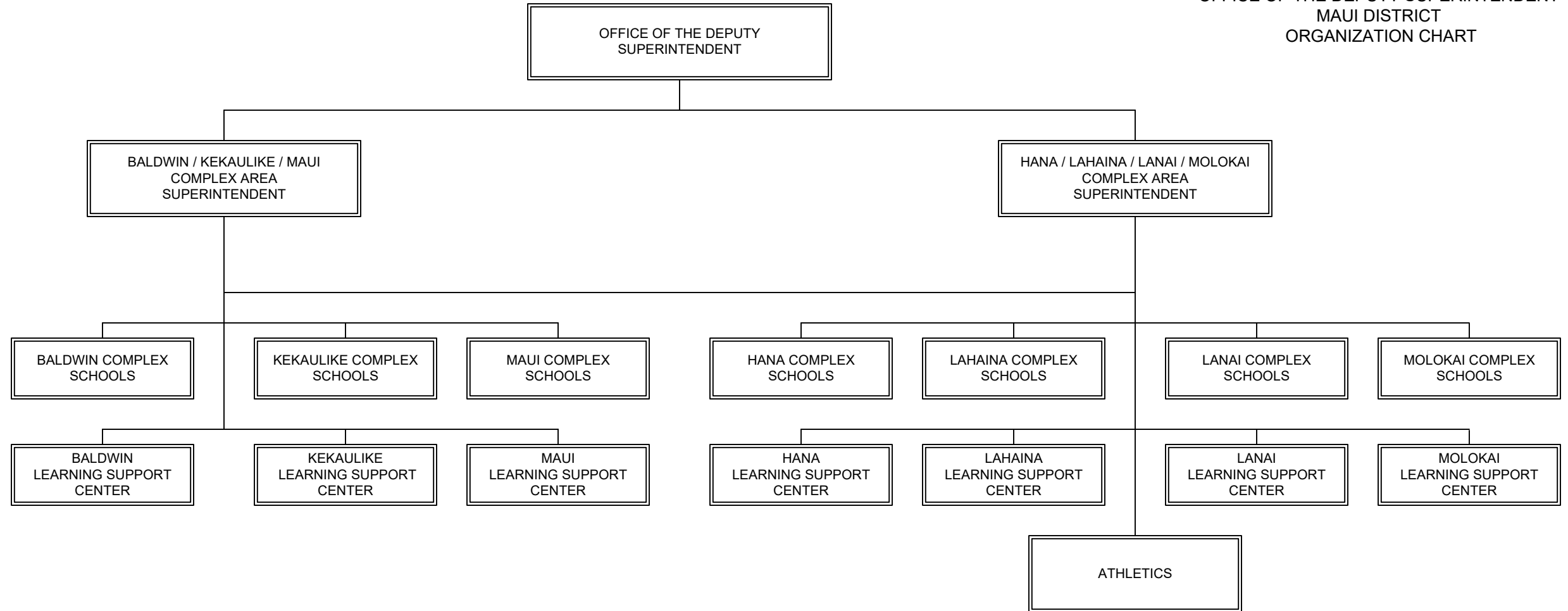

STATE OF HAWAII  
 DEPARTMENT OF EDUCATION  
 OFFICE OF THE DEPUTY SUPERINTENDENT  
 MAUI DISTRICT  
 ORGANIZATION CHART

Deputy Superintendent  
60000

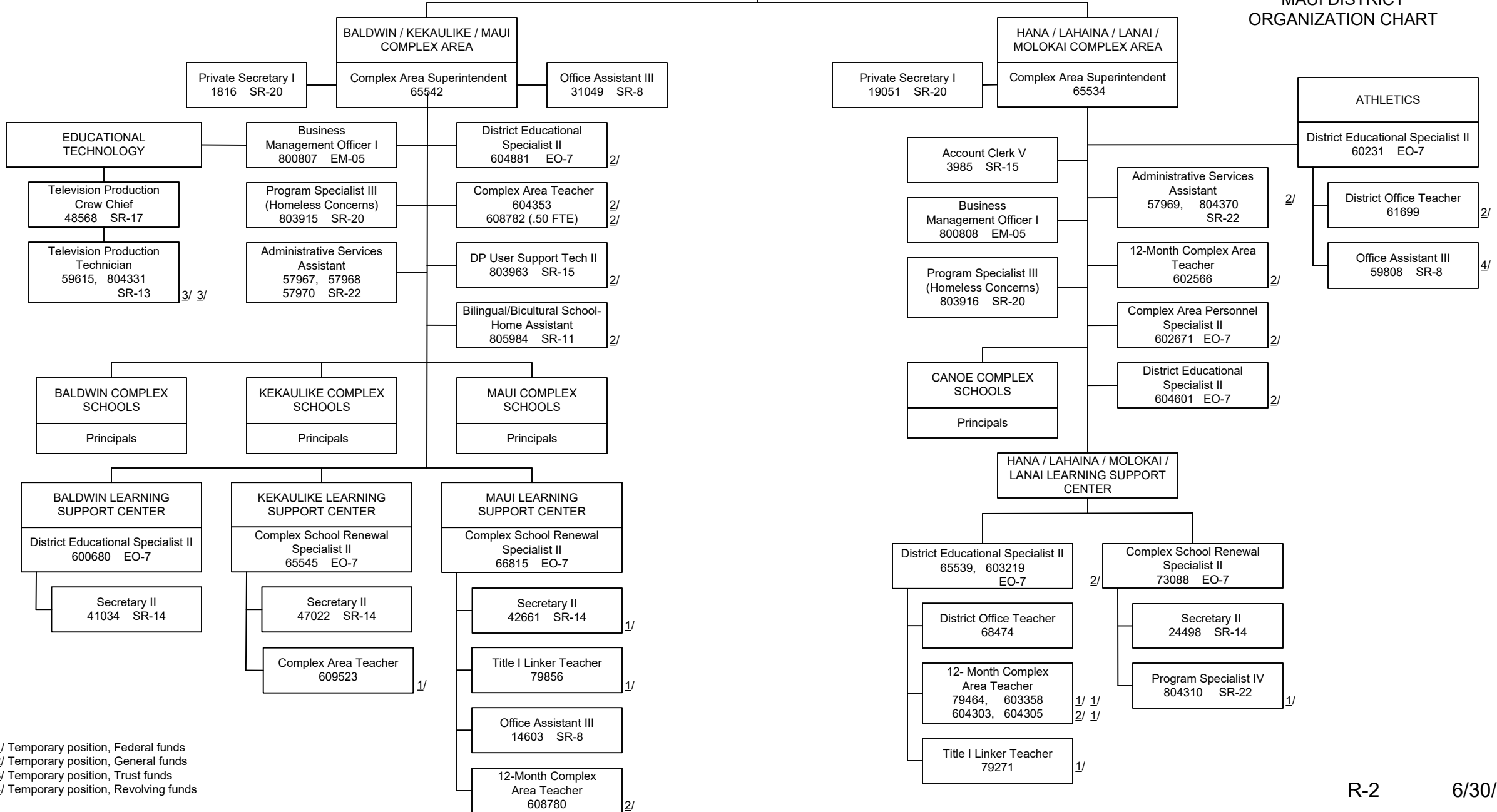

1/ Temporary position, Federal funds  
 2/ Temporary position, General funds  
 3/ Temporary position, Trust funds  
 4/ Temporary position, Revolving funds

STATE OF HAWAII  
DEPARTMENT OF EDUCATION  
OFFICE OF THE DEPUTY SUPERINTENDENT  
MAUI DISTRICT  
ORGANIZATION CHART

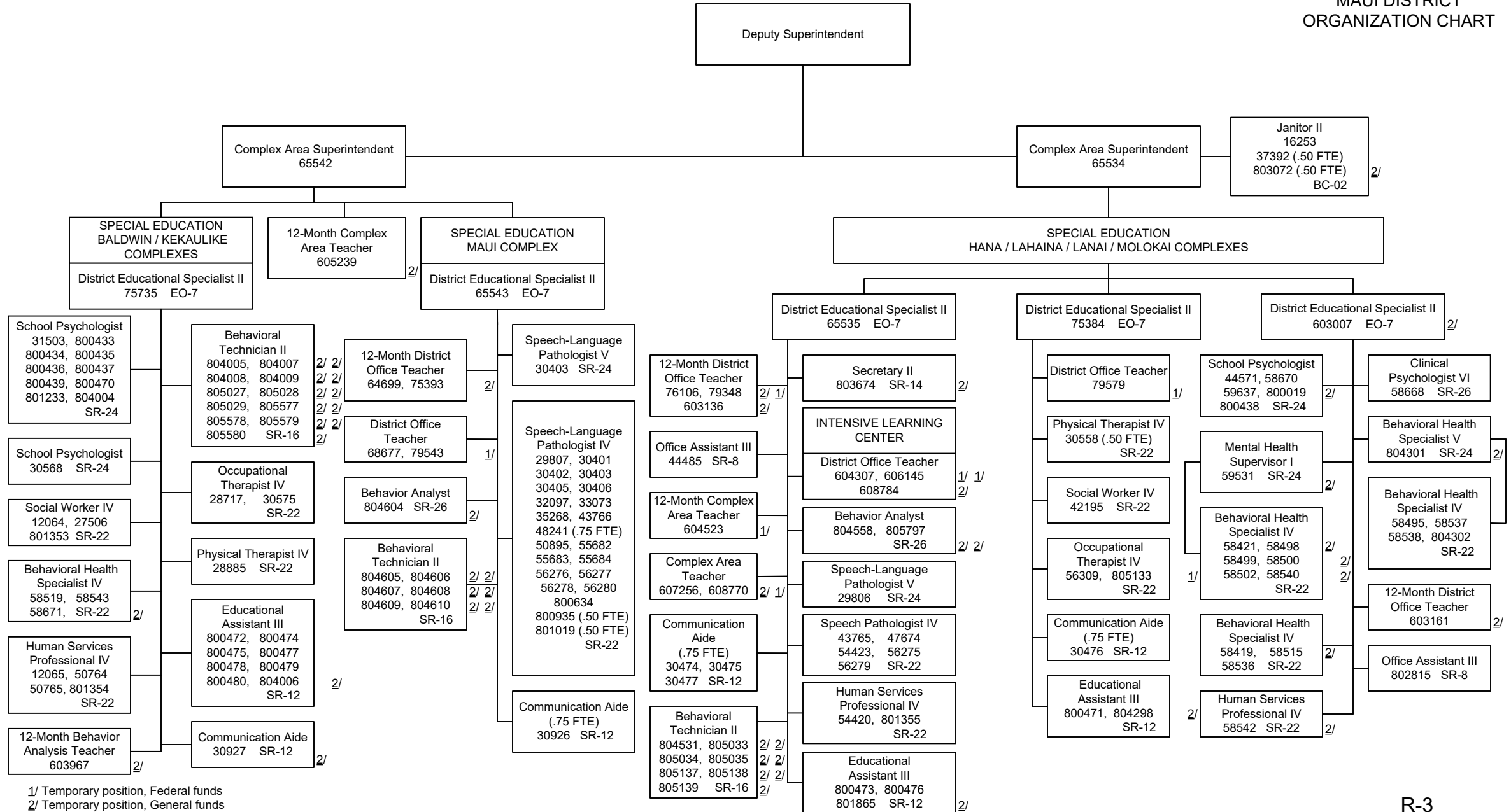

1/ Temporary position, Federal funds  
2/ Temporary position, General funds

STATE OF HAWAII  
DEPARTMENT OF EDUCATION  
OFFICE OF THE DEPUTY SUPERINTENDENT  
MAUI DISTRICT  
ORGANIZATION CHART

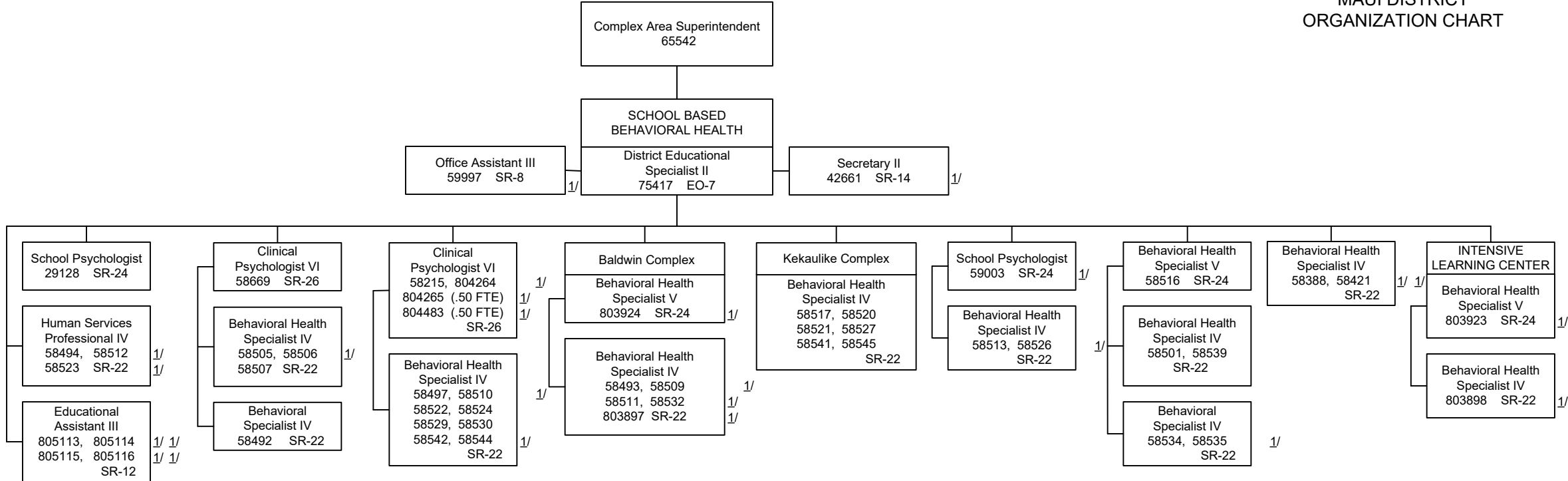

1/ Temporary position, General funds

STATE OF HAWAII  
OFFICE OF THE DEPUTY SUPERINTENDENT  
DEPARTMENT OF EDUCATION  
KAUAI DISTRICT  
ORGANIZATION CHART

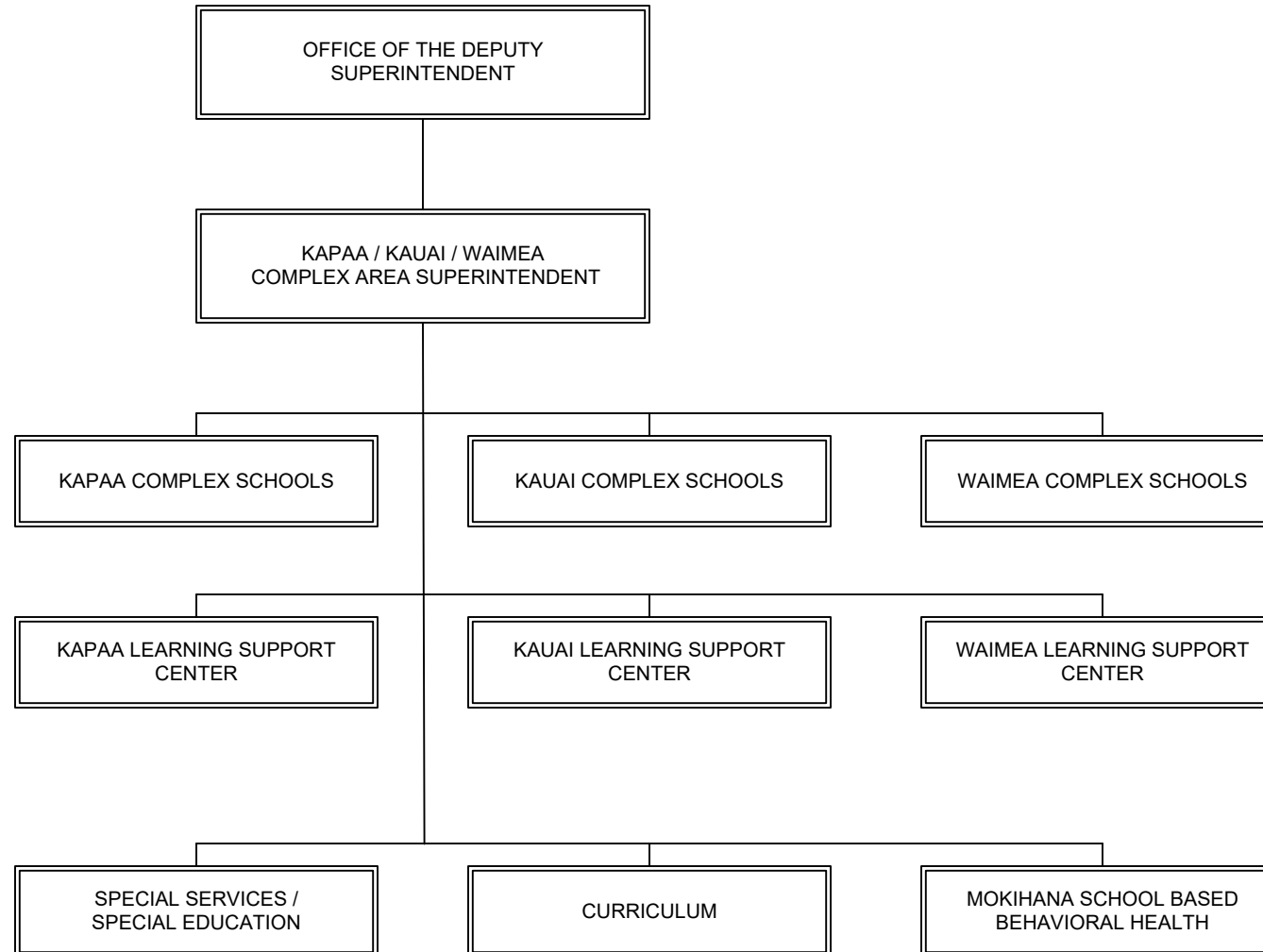



STATE OF HAWAII  
 DEPARTMENT OF EDUCATION  
 OFFICE OF THE DEPUTY SUPERINTENDENT  
 KAUAI DISTRICT  
 ORGANIZATION CHART

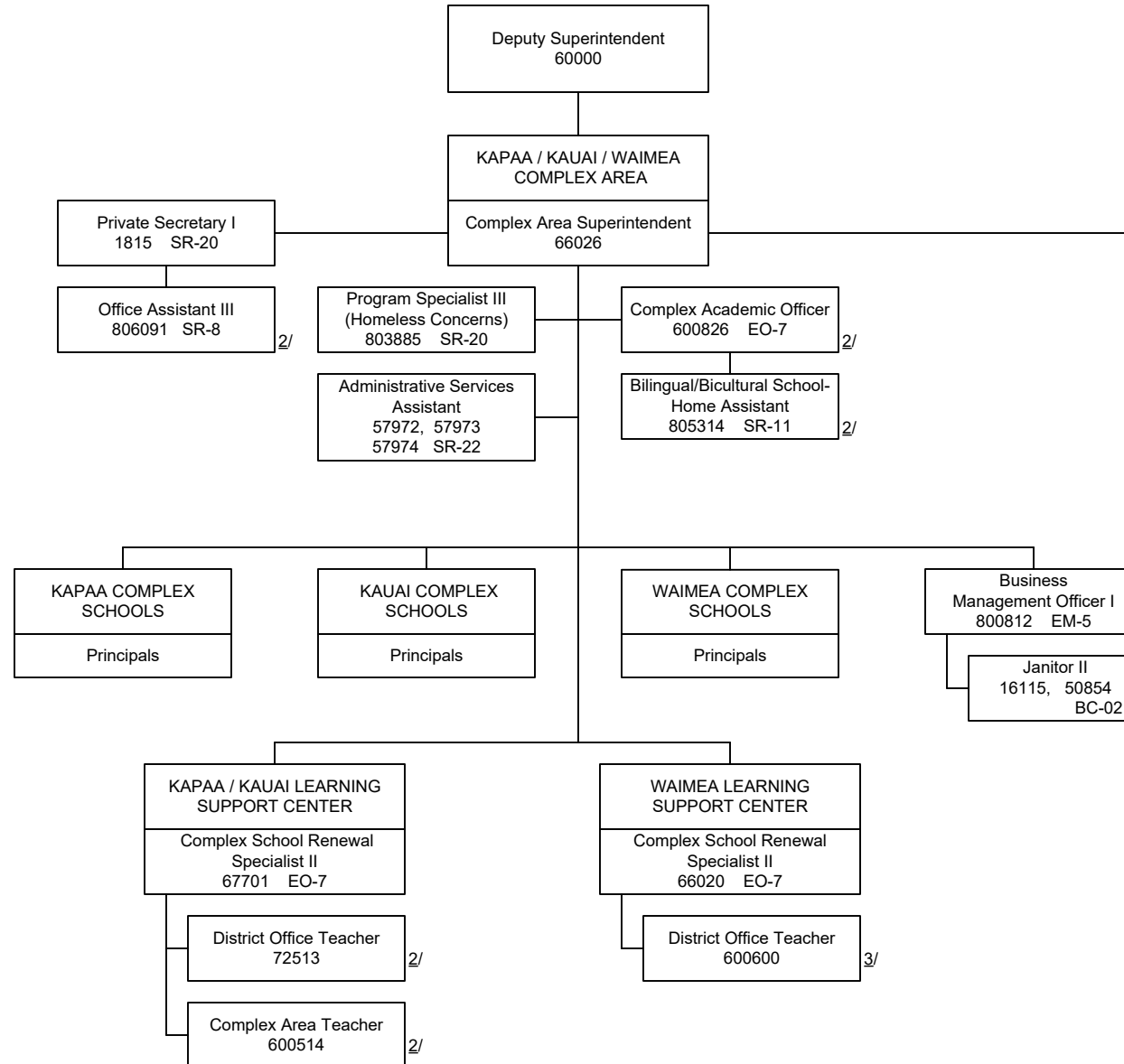

1/ Temporary position, Federal funds  
 2/ Temporary position, General funds  
 3/ Temporary position, Trust funds

STATE OF HAWAII  
DEPARTMENT OF EDUCATION  
OFFICE OF THE DEPUTY SUPERINTENDENT  
KAUAI DISTRICT  
ORGANIZATION CHART

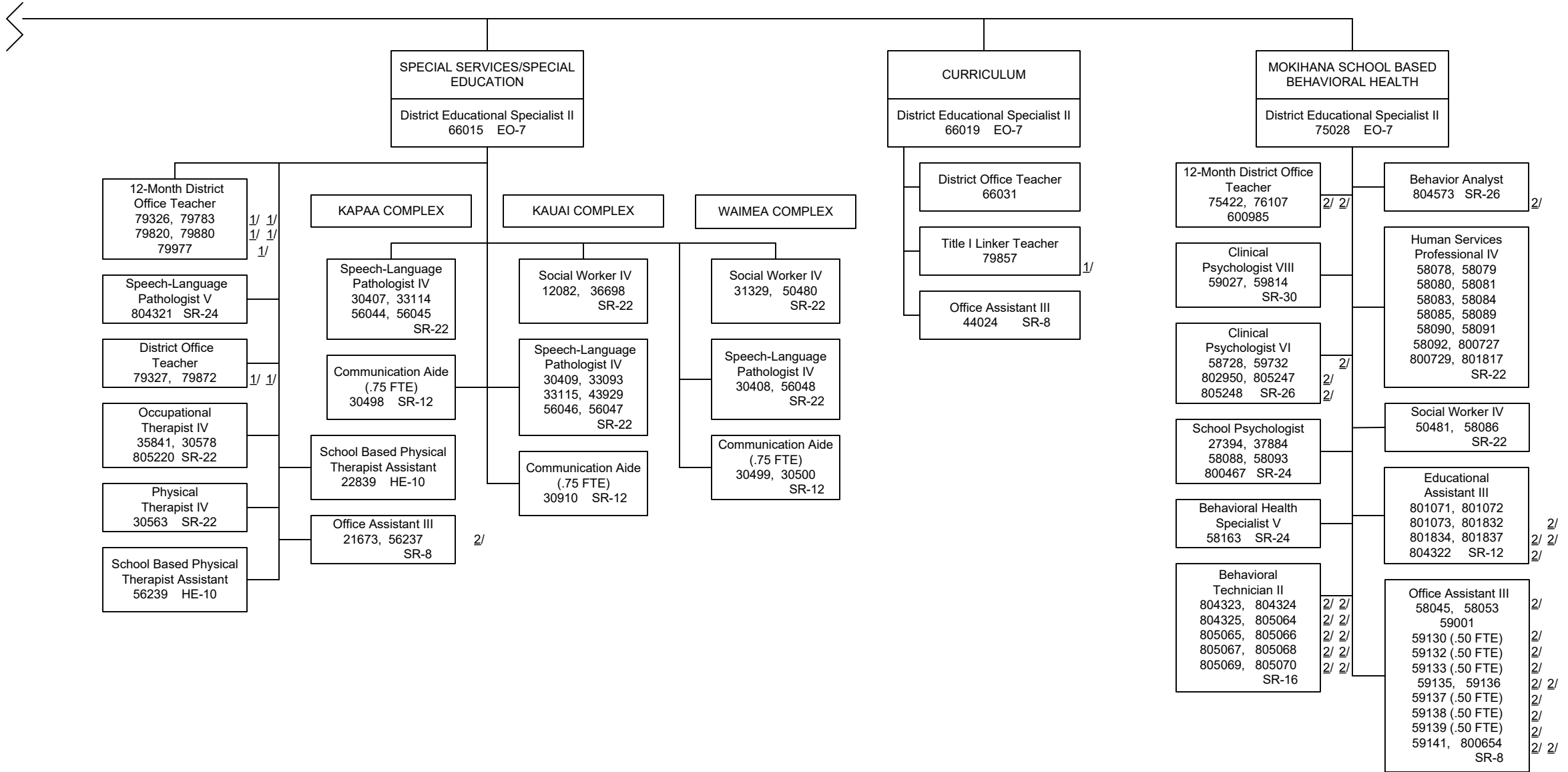

1/ Temporary position, Federal funds  
2/ Temporary position, General funds

## DEPARTMENT OF EDUCATION

### FUNCTIONAL STATEMENT

The Department of Education (DOE) is a department in the executive branch of the state government. The department manages the statewide systems of public schools and public libraries. The legislative appropriations of state general funds and special funds, and federal funds and grants received to support public school and public library programs, are administered by the DOE on a statewide basis and subject to executive branch expenditure restrictions.

As provided by law, the DOE is subject to executive branch policies and controls relating to state education functional planning, financial administration, administrative rulemaking, collective bargaining negotiations, and acquisition and disposition of school land.

The DOE is also dependent on other executive branch agencies which function as state central service agencies for certain systems support services, such as legal services (Department of the Attorney General), and main frame computers (Department of Accounting and General Services).

The head of the DOE is the Board of Education (BOE). The BOE is a policy-making board consisting of 9 members appointed by the Governor with the advice and consent of the Senate, and a public high school student who is selected by the Hawaii State Student Council and serves as a non-voting member, and a military representative who is appointed by the senior military commander in Hawaii and serves as a non-voting member.

#### Public School System

The Department is the only statewide public school district in the country. It is organized as a tri-level system (state offices, complex areas, schools) led by the Superintendent of Education.

Seven state offices centralize the functions, resources, and technical assistance needed to support and maintain all schools across the system. This ensures equitable access to education services, utilizes economies of scale in the purchasing and distribution of resources, and provides oversight to ensure compliance with laws, policies, and regulations. The state offices are responsible for the functions that provide the infrastructure and resources to support the entire organization. They are also responsible for developing and communicating the standards, guidelines, and practices that direct the work of the system.

Schools within the Department are organized under 15 regional administrative units called Complex Areas, each supervised by a complex area superintendent who reports directly to the Deputy Superintendent. The complex area offices act as liaisons between state offices and schools, providing direct local support to address the specific needs of the schools within their respective areas or seek additional support from the state offices. The complex area consists of at least two school complexes, each school complex consisting of a high school and its feeder middle and elementary school.

Public schools are the primary units of the organization responsible for implementing educational services that comply with Department standards and guidelines. Schools are responsible for providing safe learning environments, delivering appropriate curricula and instructional programs, and ensuring student growth and learning for their unique communities. There are 257 Department schools and 37 public charter schools.

The scope of educational programs and services of the public schools regularly encompasses grades kindergarten through 12 (K-12), and such pre-school programs and community/adult education programs as may be established by law. In addition to regular programs of instruction and support services, public schools offer special programs and services for qualified students with disability, gifted and talented students, students with limited English language proficiency, and students who are economically and culturally disadvantaged, school-alienated, or instructionally confined.

Other public education service programs administered by the public school system include regulation of private trade, vocational, and technical schools; public summer schools; Western Association for Schools and Colleges (WASC) accreditation program for public secondary and adult education schools, and private secondary schools in Hawaii; the A+ Program for after-school care of "latchkey" children; and various programs and services funded by the federal government, trusts, and private agencies that may benefit eligible persons in the general public as well as public school students.

### Public Library System

The public library system is administered by the State Librarian. The public library system operated the Hawaii State Library, the Library for the Blind and Physically Handicapped, public libraries, community public and school libraries, and bookmobile services.

Special library services, including interlibrary loans, federal documents depository and inter-agency (municipal, state, and federal) exchange, are provided by the Hawaii State Library. The Library for the Blind and Physically Handicapped provides transcribing services to the blind; produces, maintains, and makes available specialized collections and services to the blind and physically handicapped; and assists state-supported residential, medical, educational, and correctional institutions in their library development and operations. Materials selection, ordering, cataloging, preparation, and binder services for all libraries are centrally administered.

### Agencies Attached to the Department of Education

The following agencies are attached to the Department of Education for administrative purposes only:

- Hawaii Teacher Standards Board (as established by Section 302A-801 to 803, Hawaii Revised Statute): Establishes standards for the issuance of public school teacher licenses and credentials; adopts policies and standards, including fees, for teacher licensing and credentialing; and adopts rules pursuant to Chapter 91, HRS.
- Executive Office on Early Learning (as established by Section 302L-7, Hawaii Revised Statutes): Statutorily established to develop the early learning system in Hawaii, including adopting high-quality policies and standards that incorporate research-based, developmentally-appropriate practices associated with better educational outcomes for children. This includes administering the State's public prekindergarten program, according to rules adopted by the office pursuant to Chapter 91, HRS."
- School Facilities Authority (as established by Section 302A-1702, Hawaii Revised Statutes): Statutorily established to be responsible for all public school development, planning, and construction related to capital improvement projects assigned by the legislature, governor, or board of education.

## **DEPARTMENT OF EDUCATION**

### **BOARD OF EDUCATION**

#### **FUNCTIONAL STATEMENT**

The Board of Education (Board) heads the Department of Education, as provided by Section 26-12, Hawaii Revised Statutes (HRS).

The Board in accordance with applicable laws and its By-Laws, formulates statewide educational policy, adopts student performance standards and assessment models, monitors school success, and appoints the Superintendent of Education as the chief executive officer of the public school system, as provided by law (Article X, Section 3 of the Constitution of the State of Hawaii, and Section 302A-1101, HRS).

The Board formulates policy and appoints the State Librarian as the chief executive officer of the public library system, as provided by law (Section 312-2, HRS).

The Board, through the State Librarian, has direct control of the public library system, excluding school libraries (Section 302A-1120, HRS).

The Board appoints the members of the State Public Charter School Commission, which serves as the statewide charter authorizer for charter schools, with the power and duty to issue charters, oversee and monitor charter schools, hold charter schools accountable for their performance, and revoke charters (Section 302A-1101(d), HRS).

**DEPARTMENT OF EDUCATION**  
**OFFICE OF THE SUPERINTENDENT**  
**FUNCTIONAL STATEMENT**

OFFICE OF THE SUPERINTENDENT OF EDUCATION

The Superintendent of Education is responsible for efficiently and effectively administering the public school system in accordance with law and educational policies adopted by the Board of Education.

- Executes Board policies.
- Recommends to the Board the public school system's program goals, objectives and plans, performance standards, capital improvement plans, and budgets.
- Develops and establishes with the approval of the Board a comprehensive accountability and assessment program for the public school system.
- Presents concise reports periodically at board meetings covering, but not limited to, the following:
  - Public school system's goals, objectives, plans and progress toward them.
  - Major program developments.
  - Enrollment developments and projections.
  - Personnel developments.
  - Budget status, current fiscal year and plans for the next fiscal year.
  - Major accomplishments and problems.
  - Outlook for the future.
- Assists the Board chairperson and the respective Board of Education committee chairpersons in strengthening the roles of Board of Education committees.
- Provides administrative leadership in collective bargaining and maintenance of relationships with professional organizations and unions.
- Provides administrative support to the Board of Education, committees, advisory councils and commissions.
- Maintains liaison on behalf of the Board of Education with the State Legislature, governor, the various state departments and the people of the State of Hawaii on matters pertaining to the administration of the public school system.
- Presents for Board approval nominations and appointments of all assistant and Complex Area Superintendents.

- Promotes partnerships between the public school system and various sectors of the community: business, trusts and foundations, and other government agencies.

The following offices report directly to the Superintendent of Education:

#### 1. OFFICE OF STRATEGY, INNOVATION AND PERFORMANCE

The Office of Strategy, Innovation and Performance (OSIP) is charged with policy development and analysis, promoting a culture of data-driven decision making administering statewide assessments and federal and state accountability for schools.

#### ASSESSMENT AND ACCOUNTABILITY

This branch oversees the development and administration of student assessment, school evaluation and system evaluation components of the department's accountability system. The branch will provide support related to the departmental evaluation and student testing.

##### Assessment Section

- Administers the public school system's statewide summative student assessment program, which may include a variety of norm and criterion referenced tests using both traditional and performance-based measures.
- Administers the department's participation in and compliance with the National Assessment of Educational Progress, or known as NAEP.
- Identifies assessment instruments and practices that are used to measure system, school and individual student attainment of the Board's content and performance standards.
- Identifies assessment instruments and practices that are used to measure system, school and individual student attainment of the federal and state statutory requirements
- Provides student assessment data used in monitoring school quality and student achievement for the statewide assessment and accountability system.
- Provides assessment data for measuring compliance with the Board's policies and regulations and the NCLB.
- Serves as a clearinghouse of information on student assessment techniques and tools.
- Develops or collaborates with other public agencies in the development of innovative assessment techniques for possible statewide and school adoption and for use in the statewide assessment and accountability system.
- Serves as liaison to community groups, federal offices and state agencies and commissions involved with the development and dissemination of tests and information about tests.

##### Accountability Section

- Assists with the coordination of, and support for the statewide assessment and accountability system; develops and implements components related to school and system evaluation and conducts research and development work on educational indicators and analyses.

- Prepares annual school-by-school, local education agency and state education agency accountability reports to meet federal, state, and department requirements.
- Provides information regarding the performance of schools on educational indicators for improvement uses and accountability needs of the department, policy makers and the general public.

#### DATA GOVERNANCE and ANALYSIS BRANCH

The branch is responsible for data quality assurance and ensuring appropriate data management and stewardship to align data systems and policies, providing guidance and support for both internal and external reporting functionality, conducting applied research and data analysis and defining and visualizing data analysis for internal and external understanding.

#### POLICY, INNOVATION, PLANNING and EVALUATION BRANCH

The PIPE is responsible for performance management of the state's strategic plan outcomes and major initiatives. It serves as a catalyst within the organization that proactively plans reform initiatives and monitors their effectiveness on an ongoing basis.

The PIPE Branch also is responsible for discretionary grant management, policy analysis, standards of practice and recommendations to the Superintendent, Board and the State legislature regarding policies, laws and procedures. The branch is responsible for keeping abreast of national and international best practice and research in the education policy arena and ensuring that the department's practices and policies are aligned and enable progress.

#### COMMUNICATIONS BRANCH

The Communications Branch supports the Hawaii State Department of Education (HIDOE) by developing the internal and external communication programs Provides communications services to the offices and schools of the public school system, as needed.

- Advises the HIDOE leadership and other personnel on public affairs implications of proposed actions or decisions.
- Drafts letters, memos, public statements and speeches upon request of the HIDOE leadership. Superintendent.
- Advises and assists other state and district offices and schools in publicizing their activities.
- Prepares departmental news for all personnel, as appropriate.
- Publishes the Education Update newsletter in conjunction with regular Board of Education (BOE) meeting to report HIDOE matters.
- Reviews and recommends for printing all official publications of the Department.
- Develops among all personnel an awareness of the need for good public relationships and assists key personnel in developing communications skills through membership in professional organizations, provision of materials and training sessions, as needed.
- Monitors and evaluates communications needs and the department's efforts to meet them.
- Plans and coordinates activities for communicating with the general public.
- Issues news releases on major state-level actions, and departmental plans, programs, and activities deemed of interest and importance to the general public.



- Schedules and handles arrangements for news conferences.
- Generates and suggests story ideas for the media.
- Prepares informational pamphlets and other materials to serve public information needs.
- Promotes and maintains good relationships within the Department and special public and individuals through a variety of appropriate means, such as membership on boards and committees.
- Provides coordination of information to HIDOE leadership, the Superintendent, media, schools, and general public as needed on matters relating to school closures, bomb threats, and other health, public safety, and civil defense emergencies affecting HIDOE schools.

## COMMUNITY ENGAGEMENT BRANCH

The Community Engagement Branch ensures that the Department establishes and maintains effective working relationships and partnerships with a variety of private agencies, parents, public, and community that support the public school system.

- Develops and implements strategies to facilitate interaction between the DOE and the military community involving the Joint Venture Education Forum and other identified community groups.
- Coordinates promotion partners-in-education programs with various sectors of the community: business, trusts and foundations, and other government agencies.
- Supports the establishment of locally based community bodies with extensive family participation to advise the department on the delivery of Special Education and related services.

Acts as liaison to other federal and state agencies on system-wide planning and analytical activities pertaining to the public school system.

## SCHOOL TRANSFORMATION BRANCH

The School Transformation Branch is responsible for building capacity and providing supplementary support to complex areas and schools in their school improvement efforts. The Branch's efforts are concentrated on schools identified for support and improvement through the state's federally-approved school accountability and improvement system.

The School Transformation Branch will coordinate school improvement efforts in line with the Hawaii Department of Education Strategic Plan and Hawaii Consolidated State Plan for the Elementary and Secondary Education Act (ESEA). This includes support for conducting comprehensive needs assessments to evaluate school needs, developing and implementing comprehensive improvement plans, obtaining supplementary resources based on need, and coordinating professional development and professional learning communities of complex area and school staff. The School Transformation Branch will also monitor schools and complex areas for compliance and performance as well as coordinate school improvement efforts with the Hawaii State Public Charter School Commission

The School Transformation Branch administers authorized under the ESEA as well as coordinates the implementation the ACS-WASC school accreditation process.

## 2. OFFICE OF CURRICULUM AND INSTRUCTIONAL DESIGN

The Office of Curriculum and Instruction Design (OCID) is committed to equitable access to quality education for all students. OCID's primary responsibility is to develop, coordinate, and implement high-quality practices and systems that embrace student voice, choice and needs to effectuate the priorities of the Board of Education and the Department's strategic plan.

This office provides strategic program support, technical assistance and collaborative networks to scale effective instruction and the progression of learning from Pre-K to grade 12. OCID works to remove barriers that perpetuate an opportunity and achievement gap to promote learning and growth for each student.

Under the direction of the Assistant Superintendent, the responsibilities of the office are performed by the Extended Learning Branch and Curriculum Innovation Branch.

### EXTENDED LEARNING BRANCH

The Extended Learning Branch (ELB) supports schools and complex areas to strengthen their portfolios by providing high-quality experiences and opportunities through an array of extended and extracurricular learning programs for students and educators. ELB also provides related fiscal, legislative and policy coordination for OCID.

The Extended Learning Branch is comprised of two sections: the Digital Design Team and the Extracurricular Team.

#### Digital Design Team

The Digital Design Team (DDT) provides guidance on the implementation and integration of media, information, and technology literacy tools that support student engagement and achievement. This section provides leadership in Digital Classrooms, E-School, School Librarian Services, Computer Science, and Summer School. Staff also provide consultative services that model the use of technology integration to facilitate job-embedded and collaborative opportunities for state offices, complexes, and schools.

The instructional technology design is driven by the pedagogical approach and the learning deliverables of the school design components. Integration and use of technology is leveraged to extend the capabilities of students to engage in higher sophistication of design, research, interaction, sharing, and creating.

#### Extracurricular Team

This Extracurricular Team (ET) provides focused leadership in supplementing school offerings and curriculum by providing additional opportunities for students to develop skills, character, and leadership. These programs include Homeschooling, Athletics, Athletic Health Care, Driver and Traffic Safety Education, and Student Leadership and Activities.

### CURRICULUM INNOVATION BRANCH

This Curriculum Innovation Branch focuses on the development and implementation of evidence-based practices, processes, and practices for teachers and administrators to ensure support to schools and Complex Areas as the primary facilitators of teaching and learning.

Building upon a tri-level system, OCID collaborates and consults with complex areas and schools to co-construct professional development, provide job-embedded coaching in support of school design around standards-based curriculum, instruction and assessment literacy.

Support extends around the selection of instructional materials that emphasize primary sources, authentic field-based resources, rich and complex text, quality open source documents and teacher created and peer-reviewed materials. A priority is access to an array of quality learning materials and additional learning resources to support school design projects, research and innovation.

The Curriculum Innovation Branch is comprised of three teams: Learning Support Team, Standards Support Team, and Career Readiness Team.

#### Learning Support Team

The Learning Support Team (LST) focuses on enhancing professional practice with innovative instructional strategies through content expertise and professional development for English Language Arts, Early Literacy, and Mathematics. Resources to support high-quality teaching and learning include the Learning Design Resource, a website that shares current research, curriculum, and applied learning strategies such as project-based learning and design thinking. Additionally, the LST monitors the online Professional Development Course System, which allows increased access to relevant professional learning opportunities for all teachers and practitioners in the state by offering a broad range of courses for credit.

As shifts in the classroom include our state priorities of empowering student voice, teacher collaboration and school design, LST strives to support the efforts with exploration, creativity and problem-solving around relevant pedagogy in the core content areas and professional learning.

#### Standards Support Team

The Standards Support Team (SST) provides leadership, guidance, and support to schools and Complex Areas across multiple disciplines. Content areas in SST include Fine Arts; Health Education; Physical Education; Science; Social Studies; Standards-Based Practices; and World Languages. This team delivers support resources for standards-based curriculum, instruction, and assessments to address all learners; creates, delivers, and connects the field to opportunities for standards-aligned professional learning; and highlights, creates, and leverages structures to support communication and collaboration among the tri-level system. The Standards Support Team promotes a well-rounded education and whole-child development through various models of standards-based teaching and learning.

#### Career Readiness Team

The Career Readiness Team (CRT) focuses on supporting college and career readiness through the state-level administration and support in Advanced Placement, Adult Education, Career Technical Education, Early College, GEAR UP, Gifted & Talented, Learning Centers, JROTC, and Graduation Requirements.

Partnerships are cultivated with business, industry, and community to expand curriculum capacity to support the school design. To better respond and prepare students for college, careers and the workforce, opportunities for internships and externships in business and industry sectors extend authentic learning opportunities for students and staff. Curricular relevance and innovation are accomplished through applied learning, design thinking, project-based designs,

early college/early exposure models, and service-learning embedded into the learning experience for all students.

#### VIRTUAL LEARNING BRANCH

The Virtual Learning Branch focuses on supporting schools and complexes by offering virtual solutions to educational challenges. The Virtual Learning Branch does this by developing Hawai'i-centric educational instructional resources for schools and teachers to utilize in both face-to-face and virtual environments, thus, expanding course choices for students.

The Virtual Learning Branch also encompasses the State Distance Learning Program (SDL). SDL is a fully virtual K-12 program that partners with home-base schools to offer a distance learning option for students across the state.

The Virtual Learning Branch works in collaboration with other OCID branches and state offices to facilitate both program and infrastructure needs.

### 3. OFFICE OF STUDENT SUPPORT SERVICES

The Office of Student Support Services (OSSS) primary responsibilities is to ensure all sections use evidence-based frameworks for effectively integrating multiple systems & services to address students academic achievement, behavior & social-emotional well being. Services from OSSS ensure that every student receives equitable academic and behavioral support that is culturally responsive, matched to need, and developmentally appropriate. This office provides special education services, special needs services, student support services, student health services, and alternative learning programs. Under the direction of the Assistant Superintendent, the responsibilities of the office are performed by the Exceptional Services Branch, Student Support Section, and Alternative Learning Branch.

#### STUDENT SERVICES BRANCH

The Student Services Branch focuses on providing statewide leadership in the implementation of a focused and responsive system of supports to strengthen the social, emotional and physical well-being of all students and their families and communities to impact student achievement. This includes research, development of statewide frameworks, guidance, procedures, and tools, and the provision of professional development, technical assistance, and support to complex areas.

This branch consists of two sections: Student Support Section and School Health Section.

##### Student Support Section

This Student Support Section (SSS) provides leadership and support to schools in implementing a Comprehensive Student Support System, focus on preventive and developmentally-appropriate supports and services, including interventions and strategies to address behavioral and academic student needs.

##### School Health Section

The School Health Section (SHS) provides coordination and technical oversight to support the physical well-being of all students to facilitate improved academic achievement. It coordinates school health services and partners with health-related public and private agencies.

## EXCEPTIONAL SUPPORT BRANCH

The Exceptional Support Branch (ESB) supports schools and complex areas through the research and development of policies, procedures, guidelines, and tools to ensure that children/youth (ages 3-22) with disabilities have a free appropriate public education in the least restrictive environment.

The branch consists of two sections: Special Needs Section and Special Education Section.

### Special Needs Section

The Special Needs Section (SNS) provides leadership, professional development, and technical assistance to schools and complexes in planning and implementing programs for low incidence populations for students with disabilities. This section also provides direct services to students through hearing impaired/visually impaired evaluations statewide and to students in the Pookela Special Day Program Center and program oversight for students with autism.

### Special Education Section

The Special Education Section (SES) ensures that the rights of children/youth with disabilities and their parents are protected through the implementation of federal and state laws for students with disabilities. It provides technical assistance and training to schools and complex areas on the implementation of the Individuals with Disabilities Education Improvement Act (IDEA) and Section 504 Rehabilitation Act of 1973 (Section 504) and the corresponding administrative rules.

## ALTERNATIVE LEARNING PROGRAMS BRANCH

The Alternative Learning Programs Branch (ALP) provides statewide support to schools, complexes/complex areas/districts to develop, maintain and enhance programs offering opportunities of alternative paths to success for at-promise students.

## 4. OFFICE OF FACILITIES AND OPERATIONS

The Office of Facilities and Operations (OFO) exercises technical staff oversight of business, construction and maintenance of facilities, food services, and transportation support for the public school system. The OFO develops and administers administrative rules and regulations, publishes operational guidelines and provides related in-service training, monitoring and technical assistance to schools to ensure that the support is being provided in accordance with laws, policies, and accepted principles of management. The OFO's technical oversight of the schools' support services is exercised in collaboration with the Complex Area Superintendent of the respective school districts.

The business branches of the OFO directly provide schools and state and district administrative offices with the following centralized support services: managing the statewide programs for school food services and school bus transportation services; developing, managing, and maintaining a statewide school construction program; managing the central facilities inspection and repair/maintenance programs; providing schools with consulting services in landscaping, custodial and campus security attendant programs; developing and monitoring the Neighbor Island Service Level Agreements with the Department of Accounting and General Services (DAGS); coordinating teacher and custodial personnel

housing; providing training on safety, security, civil defense, hazardous materials disposition, and traffic safety; maintaining a central mail distribution system; providing a central reprographic activity; and providing energy conservation staff services.

#### Environmental Unit

Plans, coordinates, organizes, directs, and controls a variety of engineering and environmental services to ensure compliance with applicable environmental laws, rules, and regulations, including but not limited to the Clean Air Act, the Clean Water Act, the Endangered Species Act, the National Environmental Policy Act, the Noise Control Act, the Safe Drinking Water Act, the Resource Conservation and Recovery Act, the Toxic Substances Control Act, the Asbestos Hazardous Emergency Response Act, the Archaeological Resources Protection Act, and the National Historic Preservation Act.

- Provide technical support and make recommendations for resolving environmental issues for the Department.
- Implement and maintain a program for eliminating or minimizing the emission of air pollutants for the Department.
- Implement and maintain a program for disposing domestic and industrial wastewater for the Department.
- Implement and maintain a program for assuring the safety of drinking water for the Department.
- Implement and maintain a program for managing hazardous materials, and disposing solid and hazardous waste for the Department.
- Implement and maintain a program for protecting and enhancing indoor air quality and minimizing public exposure to indoor air pollutants for the Department.
- Implement and maintain a program for protecting endangered plant and animal species for the Department.
- Implement and maintain a program for protecting or preserving historic and archaeological sites for the Department.
- Implement and maintain a program for controlling noise emissions for the Department.
- Implement and maintain a program for preparing detailed statements assessing the environmental impacts of and alternatives to Department actions that significantly affect the environment.
- Implement and maintain a program for managing the presence of friable and non-friable asbestos containing materials at the Department's schools and other facilities.

#### AUXILIARY SERVICES BRANCH

Provides staff services support to the Facilities Development and Facilities Maintenance branches, develops and monitors the Neighbor Island Service Level Agreements with the DAGS, monitors the school's responsibility in meeting facilities related Energy Conservation Requirements; and provides management analyses services, including methods and procedures studies, personnel staffing requirement reviews, organizational analyses, statistical analyses, development of appropriate reorganization proposals, and management advisory services. Coordinates the distribution of the DOE mail using an array of carriers and mailing and addressing options.

### Project Control Section

- Provides various staff services to the Assistant Superintendent and to the OFO as a whole including general management assistance; operating budget preparation and execution; program control; financial management; obtaining project funding and providing current and final project costs; tracking of projects; and processing and preparing contracts.
- Performs Control Functions. Monitors the funds expended in providing planned services to assure funds are appropriately expended; identifies deviations from authorized and/or planned expenditures. Reviews payments to contractors for services provided in accordance with contracts. Develops financial reports at periodic intervals to report progress.
- Receives and evaluates operational data and develops program policies, procedures, standards and plans.
- Participates in the development of the capital improvements program (CIP) and repair and maintenance (R&M) budget request.

### School Support Program

- For the Neighbor Islands, coordinates the development of major R&M projects, including the determination of statewide budgets and priorities and monitoring the projects among schools pursuant to the Service Level Agreement.
- Prepares the budget request for water, sewer, courier service, school service and maintenance contracts and gas for the schools, prepares monthly projections on the status of the funds and processes all bill payments centrally. Annually calculates the monthly sewer rates for Oahu schools and submits the proposal to the City & County of Honolulu for negotiation and approval.
- Coordinates the school furniture and equipment program with Facilities Maintenance Branch, schools, and districts. Compiles and maintains the specifications for the school furniture pricelist.
- Compiles data and prepares budgetary documents and monitors plans and budgets of the EDN 400 R&M program for conformity.
- Coordinates and develops data and assists in drafting legislative proposals and testimonies on matters affecting the Office of Facilities and Operations CIP and R&M programs.

### Mailroom Unit

- Provides pick up and delivery mail service to all schools and DOE offices on Oahu and to the District Offices on the outer islands to include sorting and distributing incoming/outgoing mail using an array of mail options and equipment.

### School Energy Conservation Program

- Administers the DOE energy use and conservation program through analysis of school utility consumption, recommending energy saving methods and energy conservation, preparing budget energy requests, providing consultation services, etc.

### Hawaii 3Rs

- Coordinates the Hawaii 3Rs program for the Department of Education.

- Assists in the coordination of the Joint Venture Education Forum (JVEF) repair and maintenance projects with schools and the military.
- Coordinates the statewide playground equipment program.

#### Reprographic Section

- Provides planning, budgeting, designing, preparation, printing, and distribution services to all schools and State and District Offices in the DOE. Printed items include reports, announcements, memoranda, operational forms, curriculum guides, manuals, brochures, attendance forms, posters, and other educational materials.

#### Printing Unit

- Provides consultative services regarding printing production format, paper stock, methods of binding, production time and estimates total production costs of all printing jobs including black/white/color copying, specifications for commercial printing, funding, distribution, etc.

### FACILITIES DEVELOPMENT BRANCH

Plans, coordinates, organizes, directs and controls a variety of engineering and architectural services including land acquisition, planning, designing, project management, construction inspection, design & construction quality control, contracting, construction management, and equipping facilities and improvements for the Department of Education.

- Plans and directs the expenditure of Capital Improvement and Repair and Maintenance Funds and other operating funds released to the Department for projects.

#### Standards and Quality Assurance Unit

- Follows up on warranty requirements. Coordinates with and assists the Attorney General in litigation involving Department projects.
- Develops/revises design and construction guidelines based on feedback from staff and in consultation with the various industry organizations. Disseminates information and arranges for staff training where necessary.
- Assists in the development, approval, and revision of the Educational Specifications.

#### Planning Section

Administers and directs the planning activities of the Department's schools and other facilities. Provides land acquisition coordination and planning services; formulates and implements the Department's CIP and R&M budget requests; reviews office space needs and conducts other studies as directed.

The branch is organized into the Building Inspection Planning Unit, Planning Unit I and Planning Unit II.

#### Building Inspection Planning Unit

- Provides technical support to identify, cost, plan and evaluate repair projects and make recommendation on the condition of department facilities.



- Provide staff assistance in project tracking activities to prioritize, schedule, budget and monitor construction and subsequent warranty period for major R&M projects.

#### Planning Unit I

- Maintains annual records on use of classrooms. Prepares and disseminates Classroom Utilization Report. Determines classroom requirements and estimates future classroom needs.
- Reviews, proposes amendments and interprets administrative rule, Chapter 8-39, Use of School Buildings, Facilities and Grounds.
- Conducts studies for the development of new schools including data gathering for present and projected enrollments and geographic exemptions.
- Coordinates the preparation of complex development plans with schools and districts.
- Assists in determining the feasibility of school service boundary changes, school grade reorganizations; alternative means to accommodate overcrowded schools, and the need for new schools.
- Prepares school capacity deficit summaries by districts for the six-year planning period.
- Prepares draft budgets, executive budget requests, legislative submittals/testimonies, expenditure plans, coordinates with school complexes and districts, and finalizes the state budget draft for approval.
- Provides training, workshops, or briefings for school administrators and personnel, school organizations, public, legislators, and community members on planning and financing schools and offices, including the CIP budgeting and expenditure cycles, relationship of housing developments, or understanding of legislative appropriations.

#### Planning Unit II

- Prepares cost estimates and schedules for land, plans, design, construction and equipment for proposed projects. This includes analysis and ranking of alternatives by cost effectiveness, risk, and other factors for meeting program space needs and schedules.
- Prepares site selection studies and assists in making presentations to interested groups. Coordinates the actual acquisition of the site, including securing subdivision or consolidation approvals, state land use boundary change and/or county general plan and zoning changes. Prepares tenant relocation plans, coordinates the relocation of all tenants from the site, and disburses the appropriate compensation.
- Prepares complex development reports when a number of buildings are to be built on a site and project development reports (as required) for the individual buildings.
- Processes project initiations, makes environmental assessments, provides scope of work, prepares engineering estimates of the project cost and schedule, and as applicable, preparing an analysis of alternatives for providing the program spaces required. Prepares and files environmental notices for each project as necessary.
- Coordinates the development of future school sites and existing school properties.
- Processes requests for review of environmental impact statements and environmental assessments for change of State zoning and county zoning

and county zoning classifications, subdivision requests, and other county and State requests related to housing developments.

- Coordinates and organizes responses to developer requests related to future school sites, including fair share contributions, State Land Use Commission submittals, and county zoning applications.
- Researches, analyzes, prepares responses or possible solutions to requests for easements, revocable permits, long-term leases, executive orders, return of surplus lands, exchange or purchase of land for schools, encroachments or other problems related to school sites or department office locations.

#### Project Management Section

Provides in-house and consultant design services for new facilities and repairs or alterations of existing facilities. Generally, the Project Management Unit I performs in-house design of engineering projects and project management services; Project Management Unit II provides project management services; and Project Management Unit III conducts in-house architectural design of projects and project management services.

#### Construction Management Section

Provides construction inspection; administers construction management services and contracts for construction of facilities and acquisition of furniture and equipment for such improvements; and provides services to scope work, formulate requirements, solicit bids and monitor construction activity for major R&M projects initiated by purchase order.

#### FACILITIES MAINTENANCE BRANCH

Plans, coordinates, organizes, directs and controls a variety of services, which include maintaining and repairing public school buildings and facilities; providing technical support to school HVAC systems and electrical systems; and providing the overall planning and managing of repair and maintenance support to school facilities.

Develops and administers policies, rules, regulations, and department budgets for the school custodial, school landscaping and grounds maintenance programs.

#### Purchasing Services Section:

- Provides for the centralized purchasing and storing of equipment and supplies for the branch.
- Provides for the storing, warehousing, and inventorying of materials, supplies and equipment.

#### Repair and Maintenance Engineering Section:

Provides engineering and technical support to maintain school facilities.

Develops technical specifications, estimates and administers maintenance service contracts for repair and maintenance functions, including but not limited to air conditioning, elevator maintenance contracts, refuse pickup, program bells, grease trap and fire extinguishers.

### Repair and Maintenance Operations Section:

Supports planning and implements an on-going and comprehensive program of repair and preventative maintenance of assigned facilities.

Support, Honolulu, Leeward, Central, and Windward District Units

- Provides for the overall management of repair and maintenance of school buildings and facilities; coordinates these functions with school personnel; develops a program of preventative maintenance for school buildings and facilities; and administers a variety of repair and maintenance contracts for school buildings.

Carpentry and Building Maintenance Subunit--Carpentry Group/Building Maintenance Group/Roofing & Maintenance Services

- Provides carpentry, painting, and building maintenance services in the repair, maintenance, and emergency repairs of assigned school buildings.
- Develops a program for regular and preventative maintenance of school buildings and other facilities.
- Administers contracts for a variety of repair and maintenance functions.
- Constructs "finished" wood products such as doors, cabinets, and shelving.
- Performs minor roofing repairs, inspection, and maintenance work by clearing gutters and downspouts.
- Provides utility/auxiliary services: Moving, disposal, etc.

Electrical and Plumbing Subunit--Electrical Group/Plumbing Group

- Provides electrical and plumbing services in the repair, maintenance, and emergency repairs of assigned school buildings.
- Develops a program for regular and preventative maintenance for school buildings and other facilities.
- Administers contracts for a variety of repair and maintenance functions.

School Custodial Services Program

- Provides training, workshops, and consultative services on school maintenance, custodial scheduling, and custodial practices.
- Develops supply and equipment standards, evaluates new products and recommends purchases for custodial or ground maintenance products for schools.
- Provides emergency response support as needed.

Support District Unit

Provides for those repair and maintenance services that are not regularly utilized or which are so specialized that their operations would be more efficient if they were centralized and assigned out to the other districts as needed.

General Construction and Maintenance Group I:

- Provides general construction services to maintain school facilities in good condition.

### Masonry Services

- Provides masonry support for school facilities.

### Building Maintenance Services

- Provides transport support by delivering materials and supplies as well as transporting new and used school furniture and equipment.

### General Construction and Maintenance Group II:

- Provides general construction and transport services to maintain school facilities in good condition.

### General Labor Services

- Provides physical labor to support activities such as erecting fencing, delivery/pickup of school furniture, and installing sign posts.

### Welding and Furniture Repair Services

- Provides support in metal repair work and fabrication to school facilities and structures, and maintains, repairs, and refurbishes a variety of furniture to meet school needs and to preserve the school furniture and equipment inventory.

### Automotive Service and Repair Group:

- Provides for the control and disposition of all equipment and vehicles in the branch; provides for the repair and maintenance of these equipment and vehicles; and provides for equipment operators.

### School Grounds Maintenance Unit:

- Provides and operates a centralized lawn mowing service for all islands.
- Provides landscaping plan assistance, drainage assessment and mitigation planning, school grounds maintenance technical assistance and training and school beautification consultations for all schools.

## SCHOOL FOOD SERVICES BRANCH

The School Food Services Branch develops and administers statewide program plans, budgets, policies, standards and specifications for food services operations of the public school system.

### Fiscal Management

- Prepares budgets, expenditure plans, and financial projects for the School Food Services Program.
- Provides technical assistance to the Assistant Superintendent in developing and administering fiscal policies and internal control procedures governing program expenditures, cafeteria cash collections and meal tickets,

delivery/receipt/inventory of cafeteria supplies and equipment, and other fiscal transactions of the program.

- Reviews and analyzes financial data of departmental ledgers and prepares financial reports to management for decision-making and evaluation.
- Participates in the United States Department of Agriculture (USDA) disaster relief program for the DOE.
- Coordinates the administration of the USDA Verification of Free and Reduced Price Applications; On-Site Reviews and Coordinated Review Efforts.
- Meets with independent auditors to discuss findings and recommendations of School Food Services Program audits.

#### Technical Support

- Reviews, analyzes, and develops intermediate and long-range program plans for improvement of the School Food Services Program.
- Develops and administers the DOE School Food Services Program policies, rules, regulations, standards, and specifications governing the operations of public school cafeterias.
- Promotes participation in various child nutrition programs throughout the State by disseminating information and publications, and in-servicing Complex Area Superintendent's staff, school staff and school food service managers.
- Researches, tests, and evaluates new products (food, supplies, equipment, and services) and prepares bid specifications, and promotes the introduction of new products in the statewide public school system.
- Coordinates the planning of new cafeteria kitchens, and the renovation and replacement of existing cafeteria equipment.
- Maintains liaison with other DOE state offices and State agencies on matters of mutual concern.
- Consolidates reports from schools for reimbursement claims, staffing, and purchasing information.
- Inspects food service operations of the DOE public schools for compliance with applicable federal, state, and county laws and administrative regulations and DOE program policies, standards, and specifications.
- Provides technical assistance and consultation to school principals, food service managers, and workers on improving their operations, including, but not limited to, efficient and effective utilization of facilities, equipment, supplies, and personnel; improved food preparation, handling and storage procedures and practices; reliable recordkeeping; accounting and reporting; dissemination of program information; and maintaining liaison with appropriate local field offices of other state agencies and the county governments.

#### Commodity Distribution

- Reviews the DOE menu requirements and requests commodity foods from the Office of Hawaii Child Nutrition Program (OHCNP).
- Consults with the OHCNP on food safety notification, and other USDA Commodity Distribution concerns.
- Allocates and distributes federal commodities to public schools in the most cost-efficient manner.
- Reviews use of commodities by recipient schools.

- Maintains records and prepares reports on commodity inventory and receipts.
- Administers the Department of Defense fresh fruits and vegetable commodity purchasing program for the DOE schools.

#### SCHOOL SAFETY AND EMERGENCY PREPAREDNESS BRANCH

Develops and administers policies, rules, regulations, and department budgets for the safety and security and school inspection programs to include analyzing patterns of work-related injuries in order to more effectively train and maintain a safe and healthful environment.

- Administers the safety and security program for the public school system; plans and administers a statewide program to improve school safety, security, as well as emergency preparedness.
- Under the direction of the Assistant Superintendent, administers the department's involvement with the State Civil Defense Program. Communicates with State Civil Defense and County Civil Defense in times of emergencies or natural disasters. Coordinates the designation of school facilities as evacuation shelters with State Civil Defense.
- Coordinates the traffic safety program for the public school system; maintains liaison with the county police departments and other agencies regarding traffic safety, including the Junior Police Officers (JPO) program. Serves on the Oahu Traffic Safety Committee to resolve school-related safety concerns.
- Administers the Federal requirements for National Incident Management Systems and training compliance.
- Serves as the department's liaison to the State's Risk Management Program.
- Identifies and evaluates the department's exposure to property and liability loss to minimize the total insurance, property, and casualty losses costs.
- Coordinates insurance activities and management of loss documentation through assisting the schools and offices with processes and appropriate forms for seeking reimbursement for losses through the State's Risk Management Program.
- Provides training on insurance processes, forms, and yearly requirements.
- Administers and coordinates security program for selected schools and works with strengthening partnerships with police in all four counties.
- Administers and coordinates the surveillance camera program. Provides guidance in the use of surveillance cameras. Maintains school justification for surveillance camera checklists.
- Coordinates and represents the department in developing helicopter landing guidelines and approving appropriate sites.
- Chairs the department's Statewide Safety Committee meetings. Prepares the monthly agenda, disseminates meeting minutes. Administers and coordinates the implementation of school safety committees.
- Administers the department's hazardous materials management program, including training, recordkeeping, and mitigation or disposal; coordinates and administers Hawaii Occupational Safety and Health (HIOSH) hazard communication standards and program; and maintains liaison with the Department of Labor and Industrial Relations and other appropriate agencies regarding HIOSH regulations.
- Coordinates responses to Hawaii Occupational Safety and Health (HIOSH) issues and concerns.

- Coordinates responses to issues and concerns regarding radon, safe drinking water, lead in paint, indoor air quality and electrical and magnetic fields issues and concerns.
- Coordinates the School Safety manager program with the contractor and school administrators; attends to operational matters of the program.
- Administers the school emergency preparedness program. Provides training and technical assistance to schools in the development of school emergency responses, including lock downs, shelter in place, and emergency evacuations. Provides bomb threat response training and technical assistance to schools; compiles and analyzes bomb threat information.
- Administers and implements the Department's picture identification badge program; provides ID production services for all school level administrators, schools on military bases, and all district and state employees; maintains employee ID database of all IDs issued.
- Manages and coordinates the school fire inspection program. Acts as liaison to State Fire Council and County Fire Departments. Represents the Department in all fire inspection related matters including fire code violations and fire safety concerns.
- Coordinates the School Inspection Program with schools; works with the Facilities Development Branch, Facilities Maintenance Branch, and the Neighbor Island Department of Accounting and General Services to address concerns raised by the school inspections.

## STUDENT TRANSPORTATION SERVICES BRANCH

The Student Transportation Services Branch is responsible for the statewide program planning, budgeting, implementing, enforcing and evaluating of student transportation services for eligible public school students in accordance with Section 302-406, Hawaii Revised Statutes. The program provides safe, timely, and efficient student transportation services to eligible students to attend and participate in schools, designated programs, and other services statewide.

The branch organization is divided into three parts: Director, Field Operations Section, and Administrative Section. The functions of each section are summarized below.

### Director

- Develops and administers contracts that procure school transportation services from privately-operated school bus contractors for public school students, as required.
- Develops, prepares, and issues policies, guidelines and procedures related to student transportation requirements pursuant to Hawaii Revised Statutes, Administrative Rule, Board Policy, and Standard Operating Procedures.
- Identifies training needs of its constituency – including students, schools, bus drivers, bus aides, contractors, and others - then develops appropriate training modules to ensure student safety and efficient service levels.
- Represents the Department at school bus contractors' and other meetings as necessary.
- Provides information on federal, state, and contract requirements to schools, parents, media, and other interested parties.
- Prepares and provides written and oral testimonies/reports to the Superintendent and/or other state officials, the Board of Education and its committees, to the legislative bills and resolutions.

## Field Transportation Section

- Oversees the delivery of school transportation services to students, schools and communities.
- Oversees the implementation of the Contract Performance Management Program that provides input, guidance and support to contractors on ways to maintain consistent compliance with contract specifications and conditions in a non-punitive manner.
- Serves as the Department's primary point of contact/liaison for student transportation concerns.
- Conducts routine audits of driver qualification files, aide qualification files, and active school bus vehicles to ensure compliance.
- Investigates, resolves, and records service and safety complaints.
- Reviews, approves, audits, procures, and distributes monthly Oahu Transit Services bus passes for eligible Oahu island students who do not have access to contracted bus services.
- Enforces Department of Education (DOE) bus pass procedures.
- Assists in the determination of student eligibility for services being requested.
- Assists with managing student behavior on the bus.
- Ensures that bus drivers and bus aides are properly trained.
- Coordinates special education student transportation requests received from school administrators and district officials.
- Collects, evaluates, and maintains statistics related to contracted student transportation services for evaluation purposes.

## Administrative Section

- Reviews, processes, and maintains applicable DOE employment forms for school bus contractors' personnel.
- Develops, prints, distributes, and maintains student transportation forms to meet federal, state, municipal, and Departmental transportation requirements.
- Prepares budget requests and other related budget documents and properly performs all budget functions.
- Provides oversight relating to the collection of student bus fares and seeks accountability for the collections.
- Ensures the proper and prompt payment of program claims.
- Audits deposits into special funds and disburses available funds as required to meet contractual obligations.
- Uses modern technology to plan bus routes.
- Uses modern technology to track the activity of vehicles.
- Creates, maintains, and supports a wide range of transportation data repositories.
- Manages all Human Resources duties for the Branch such as, recruitment, orientation of new employees, civil rights complaint, disability and workman's compensation issues, as necessary.



## 5. OFFICE OF FISCAL SERVICES

The Office of Fiscal Services manages the Department of Education's (DOE) accounting, budget, and procurement activities and systems to serve the needs of the schools, school complexes, complex areas, and the state central office. The office is responsible for the following:

- Developing and implementing long-term and short-term financial activities.
- Leading the department's accounting, budgeting, and procurement operations.
- Providing timely, accurate, and user-friendly information and reports in each of the respective areas, i.e., clear guidelines/procedures for completion of documents, and that the guidelines/procedures are aligned with the department's goals and objectives.

### ACCOUNTING SERVICES BRANCH

The Accounting Services Branch provides accounting, payroll, vendor payment, fixed assets, inventory, and fiscal operations school-, complex area-, and state-level support in the public school system; and coordinates copy machine services in the DOE offices located in the Queen Liliu'okalani Building.

#### Accounting Section

The Accounting Section administers and accounts for all funds, expenditures and financial commitments incurred by the department through a centralized accounting system in conformance with the state comptroller's rules and regulations. The section assists schools and offices in developing and implementing corrective actions in response to audit compliance issues. The section develops training modules and assures that all appropriate personnel are trained in accounting, cash management, payroll, vendor payments, fixed assets, and inventory transactions.

#### Reporting, Analysis, and Reconciliation Unit

- Provides regular monthly, quarterly, and annual financial reports and detailed transaction reports of the department's financial operations, specialized reports to the courts, legislature, federal government, and other reports as required.
- Provides financial support for the transfer of funds between No Child Left Behind grants.
- Prepares monthly BOE financial and ad hoc reports.
- Prepares annual financial reports for grants received from federal, state agencies, and other non-profit organizations.
  - Prepares the National Public Education Financial Survey to the National Center of Education Statistics (NCES) cross-walking department expenditures to conform to the Common Core of Data which is used to determine state funding allocations for Title I, ESEA Programs (Migrant, Handicapped, Neglected and Delinquent Children), Impact Aid, Indian Education, and Individuals with Disability Act (IDEA) grants.
  - Prepares the Annual Survey of Local Government Finance report that is aggregated by the U.S. Census Bureau to compare revenue and expenditure resources by local education agencies.
  - Prepares the quarterly and annual Principal's Financial Report from

each school to report the quarterly activity to the state comptroller for the non-appropriated local school funds.

- Prepares the department's indirect cost rate proposal to the federal government to negotiate a rate agreement for use on the department's federal grants to reimburse the state for central services costs.
- Provides technical and consultative assistance to state, complex area, and school level personnel relative to accounting procedures, regulations, and the financial management of their accounts.
- Prepares the trial balance, income statement, statement of cash flows, and all audit schedules, including leases and liability accruals, for the department as requested by the external auditors for the department's annual financial and single audit.
- Provides technical support to external auditors for the department's annual financial and single audit.
- Updates the department's Uniform Accounting Codes, which is published in the Financial Management System (FMS) User Policy and Process Flow Guide, Chapter 2, Accounting Codes.
- Updates and maintains the FMS accounting code tables and develops and maintains interface programs to perform accounting functions effectively and efficiently.
- Develops and establishes accounting processes for new FMS requirements.
- Processes form FMS-AC4, Request for Change of Accounting Codes and/or Amounts, from all schools and offices requesting corrections for revenues or expenditures in their bond, general, federal, special, and trust fund accounts.
- Reviews and makes corrections to Department of Accounting and General Services (DAGS) semi-monthly payroll cost interface received from DAGS into the department's FMS.
- Maintains and updates the TSEAS Prog IDs for processing and accounting for TSEAS cost.
- Maintains and revises FMS "job coding" system, FMS mid-year and year-end close processes, inception-to-date and transactions year financial reports, and provides continuous coding for new appropriations and projects and FMS enhancements in order to accommodate R&M/CIP responsibilities transferred from DAGS.

#### Cash Management Functions

- Accounts for all cash receipts from schools and offices.
- Maintains multiple central collections accounts for all receipts from schools and offices and to download bank deposit information from the commercial bank to school accounts to support general school, school lunch, student transportation, and after-school lunch collections.
- Prepares treasury deposit receipts (TDR) to summarize transactions from schools by funds, source codes, and object codes to the state treasury.
- Reconciles monthly the multiple central collection account balances to the bank statement.
- Monitors federal grant cash requirements daily and draws-down cash semi-monthly and, as needed, for all federal grants received by the department through the GAPS, Smart Link, and ASAP payment systems.

- Provides financial data to Budget and Finance (B&F) to monitor selected federal accounts to meet the federal Department of Treasury Cash Management Improvement System (CMIA) monitoring requirements.

#### Fixed Assets Functions

- Manages repair & maintenance and construction-in-progress (R&M/CIP) financial responsibilities received from DAGS for general, special, and bond funds. These responsibilities include providing monthly/annual financial reports; posting appropriations, allotments, and cash; special fund assessments; and providing on-going technical assistance.
- Reconciles the department's operating and R&M/CIP fund accounts to the DAGS accounts.
- Administers, controls, coordinates, monitors, and maintains a comprehensive computerized inventory management, accounting, and reporting system for the department in compliance with state, federal, contract and donated requirements relative to the department's acquisition, transfer, disposal, and claim for lost/stolen properties.
- Prepares the fixed asset roll forward schedules for the department as requested by the external auditors for the department's annual financial and single audit.

#### Accounting Systems Unit

- Supports the processing and maintenance requirements of the DOE Financial Management System (FMS) and the state wide Financial Accounting and Management Information System (FAMIS).
- Provides system solutions and technical guidance to the Reporting, Analysis, and Reconciliation Unit in developing and writing of policies and procedures, and overseeing the issuance and maintenance of User Guides.
- Provides system training to the Unit's staff.
- Reviews the section's processes, policies and procedures for operational efficiencies and continued compliance with federal, state, and DAGS requirements. Recommends corrective action as needed and coordinates with department staff to implement the required changes.
- Responsible for implementation, evaluation, improvement, support, review, maintenance, and monitoring of Accounting modules of the state wide Enterprise Resource Planning (ERP) system, and as well as DOE automated systems as they relate to the functional responsibilities of the Accounting Section.

#### Operations Section

- Supervises the pre-auditing of all payroll payments for employees and final post audit of all vendor and contract payments.
- Provides guidance and assistance to the department in all activities of the payroll and vendor payment functions.
- Serves as the liaison with other state agencies in payroll and vendor payment matters.
- Administers and coordinates the Purchasing Card (P-card) program for the department.

## Vendor Payment and Payroll Unit

### Vendor Payment Functions

- Pays all DOE vendor obligations within 30 days of receipt of goods/services.
- Locates and verifies errors, analyzes cause, and adjusts/corrects system.
- Performs final post-audit for legality and propriety of claim vouchers, covering payment for all DOE obligations; examines invoices, approval to pay, contracts, and other authorizing documents to confirm validity and accuracy of claims; maintains auxiliary records of travel and other claims.
- Controls the activities relating to the issuance of the DOE Vendor Payment checks, maintains records and authorizations relating to disbursement of checks, and maintains cash records and authorizations relating to disbursement of checks, and maintains cash records of all bank deposits and withdrawals.
- Reports expenditures to the statewide Financial Accounting and Management Information System (FAMIS) and reimbursement from DAGS.
- Develops, implements, and updates travel guidelines for the department; tracks and updates out-of-state travel database for future references and inquiry.
- Maintain the DOE Vendor Table.
- Maintain and administer the P-Card Program which includes issuing new P-Cards, cancelling P-Cards for transferring, retiring and terminated cardholders, assisting cardholders and clerical support staff with problems and questions in the third party program, contacting bank to increase/decrease cardholder limits and update cardholder profiles, following-up with cardholders for missing and incomplete supporting documents, preparing the Non-Compliant Cardholders List for missing and incomplete supporting documents, tracking annual cardholder agreement renewals, preparing a list of cardholders who have not renewed the agreement, suspending cardholders for non-compliance and reinstating cardholders when program requirements are met.

### Payroll Functions

- Pays all DOE employees (certificated, classified, hourly or casual hires) twice a month in conjunction with collective bargaining contract provisions.
- Performs final pre-audit of all DOE payrolls.
- Validates payroll payment authorization, legality, and propriety. Controls mandatory federal and state withholdings.
- Calculates hourly/daily earnings to correct semi-monthly payroll for personnel and attendance actions to assure all DOE employees are properly compensated for each pay period.
- Effectuates payroll change schedule for central input of DOE payrolls under EDP procedures.
- Posts and maintains records of individual earnings for each DOE employee.
- Distributes payroll checks and statements for the entire DOE, including

payroll checks and statements that are mailed to individual employees (substitutes).

- Pre-audit and processes workers' compensation payments and wage separation reports for unemployment insurance purposes.
- Verifies hourly/daily earnings to dollars calculation and effectuates payroll change schedule to make payment for Vacation Leave from the Form G-2 (Applications for Transfer of Vacation and Sick Leave Credits or Payments in Lieu of Vacation).
- Responds to inquiries on all aspects of payroll from schools, offices, individual employees and Unions.
- Verifies employment and wages for financial institutions, Hawaii Housing, and the Department of Human Services.
- Prepares duplicate statement request, lost check requests, and duplicate W-2 requests.
- Researches and provides information to comply with subpoenas.
- Writes, updates, and maintains the DOE Payroll handbook. Provides guidance and assistance to the schools and offices for all aspects of payroll.
- Processes salary assignments.

#### Leave Management Unit

- Works in close coordination with the Office of Talent Management (OTM) to ensure that appropriate leave benefit information and interpretations from the Collective Bargaining Unit Contracts, DOE School Code and Hawaii Revised Statutes as contained in the OTM Standard Practices (SP) are properly administered.
- Provides guidance and assistance to schools and offices in applying the OTM Leave SPs, and reviewing/auditing leave earnings, usage, and balances on the Form 7 generated by the Time and Attendance (TnA) system.
- Audits employee's leave for Form G-2. (Application for Transfer of Vacation and Sick Leave Credit or Payment in Lieu of Vacation). Calculates hourly/daily earnings to dollars to make payment for vacation Leave from Form G-2
- Pre-Audits employee's leave for OTM's Post Separation Vacation Pay Deferral (PSVPD) program. Conducts final audit of employee's leave for Form G-2 (Application for Transfer of Vacation and Sick Leave Credit or Payment in Lieu of Vacation). Calculates hourly/daily earnings to dollars to make payment for Vacation Leave from the Form G-2. Coordinates PSVPD vacation payout with the Deferred Compensation and Tax Sheltered Annuity programs.
- Audits employee's leave for OTM's Leave Sharing program. Assist with the processing of the leave share donations and determine recipient payment information.
- Reviews the department's processes and procedures for operational efficiencies and continued compliance.
- Recommends corrective action as needed and coordinates with other department staff to implement the required changes.

## Operations Unit

- Directs, coordinates, supervises, and participates in the analysis, design, development, acceptance, implementation, evaluation, improvement, maintenance, and control of the state and the DOE computerized central accounting systems or parts thereof as it relates to the functional responsibilities of the Operations Section.
- Provides staff services to develop, recommend, train, guide, and implement procedures which relate to the Operations Section.
- Conducts special studies and research, ranging from technical matters to day-to-day operational concerns.
- Evaluates, monitors, and updates criteria to comply with federal and state tax reporting requirements.
- Monitors and maintains the Salary Overpayment Accounts Receivables and Payment Schedules, which are reported to DAGS monthly.
- Prepares and processes priority payroll payments.
- Research and provide information and support to comply with union grievances, Attorney General and Legislative requests, and budget provisos.
- Provides system solutions and technical guidance to the Vendor Payment, Payroll and Leave Management Units.
- Reviews the section's processes, policies and procedures for operational efficiencies and continued compliance with federal, state, and DAGS requirements. Recommends corrective action as needed and coordinates with other department staff, as needed, to implement the required changes.
- Test Time and Attendance system (TnA) pay profile and accrual profile changes. Test new TnA system builds and upgrades. Test changes to existing custom modules. Work with OITS to resolve issues. Accept changes for implementation into production.
- Update TnA annually for new 10-month employee schedules for the new school year. Verify leave grant date for new school year. Terminate employees for the school year ended.
- Update TnA daily for personnel actions (e.g., new hires), new schedule and leave balance update request from schools and offices, new user system access, etc. Resolve CSD level-two ticket (e.g., missing schedules for new hires).
- Assist and support the schools and administrative offices in maintaining employees' attendance and corresponding leave earnings, usage, and balances in TnA.
- Maintains the central Leave Bank account in TnA for the OTM Leave Sharing program. Adjusts recipient and donor(s) timecards in TnA for the approved leave sharing donations.
- Implements, supports, reviews, maintains, and monitors the payroll, TnA and vendor payment modules of the state wide Enterprise Resource Planning (ERP) system.

## BUDGET BRANCH

The Budget Branch assists the chief financial officer (CFO) in the preparation and execution of the public school system's operating budget.

## Budget Preparation Section

The Budget Preparation Section administers the preparation and development of the department's biennial and supplemental operating budgets. The section is responsible for the following:

- Prepares the biennial and supplemental operating budgets for the public school system, except for public charter schools.
- Prepares current services budget, projecting salary requirements and reconciling the level of funding to appropriations and ceilings.
- Develops and disseminates budget instructions, standards, and tables to schools, offices, and attached agencies, such as the Hawaii Teacher Standards Board (HTSB).
- Assists schools and offices with the preparation of budget requests, including implementation of a modified version of zero based budgeting.
- Reviews budget requests for accuracy, adequate justification, and adherence to standards.
- Coordinates the development of budget priorities and budget standards in all resource categories.
  - Recommends appropriate alternatives to meet the department's budget requirements.
  - Performs review and analysis of budget requests from schools, offices, and other agencies to address critical needs and priorities.
- Coordinates the department's development of the variance report for the multiyear program and financial plan component of the Planning-Programming-Budgeting System by providing instructions, schedules, and technical assistance to program managers.
- Coordinates with the Office of Talent Management (OTM) and program managers to monitor manpower requests to assure positions established for DOE schools and offices are within the budget.
- Provides technical assistance in budget preparation and presentation to the Board of Education (BOE), governor, Department of Budget and Finance (B&F), the legislature, state offices, complex area offices, and schools.
- Provides training and consultative services staff to develop, maintain, update, and enhance the budget preparation system to support budget functions.
- Prepares publications and communications for budget preparation.

## Budget Execution Section

The Budget Execution Section administers the implementation of the department's operating budget, monitoring adherence to policies and procedures, and making adjustments to meet anticipated needs or restrictions.

The section is responsible for the following:

- Allocates funds and positions to state and complex area offices and schools.
  - Analyzes the appropriations act and legislative worksheets to obtain details of approved budgets and legislative intent.
  - Reviews and interprets policies and procedures issued by B&F, and implements allotment changes made by the Director of Finance.

- Analyzes staff recommendations for allocation formulas and other criteria for allocating funds and positions to schools and complex area offices.
- Prepares and disseminates initial allocations to state and complex area offices, and schools.
- Adjusts allocations throughout the year to reflect buy/sell of positions, transfer of funds between programs, and other authorized flexibility measures.
- Reconciles appropriations, allocations, and allotments throughout the year.
- Completes year-end close and carryover process.
- Develops and disseminates expenditure plan instructions.
  - Prepares allotment requests (A-19).
  - Provides follow-up and liaison work with B&F and the Department of Accounting and General Services (DAGS).
  - Reconciles allotments with expenditure plans, the DOE's Financial Management System (FMS) and DAGS' balances for each appropriation and fund.
- Monitors and manages the department's budget.
  - Analyzes, solicits input, and implements reductions to appropriations and allocations by EDNs and programs.
  - Monitors and manages salary and other payroll accounts.
  - Implements flexibility provisions of lump sum budgeting (buy/sell of positions, transfer of funds, and carryover).
  - Reviews programs for budget strategies and more efficient use of operating funds.
  - Analyzes the department's financial plan and makes adjustments necessary to meet unanticipated needs or restrictions.
- Coordinates budget execution matters with external agencies, policy makers, and decision makers (B&F, legislature, auditors, BOE, superintendent, complex area and school personnel).
  - Researches and prepares reports and testimonies in response to inquiries.
  - Recommends appropriate strategies to execute the budgetary requirements.
- Coordinates system support with the Information System Services Branch.
  - Maintains tables related to the computerized budget system.
  - Prepares data files and reports required to review and analyze the budget.
  - Coordinates and monitors data transfers to data base files, i.e., Data Warehouse.
  - Provides budget execution requirements when evaluating various information systems.
- Other responsibilities.
  - Manages the Impact Aid Program, P.L. 103-382.
  - Assists in planning and development of operating biennial budgets, supplemental budgets, and other budget functions.



- Coordinates with other state offices to facilitate budgetary and fiscal procedures within the department.
- Prepares publications and other communications for budget execution.
- Provides budget execution training and consultative services to schools through budget hotlines and presentations for school administrators, clerical personnel, and other program managers.
- Coordinates, assists, prepares, and implements the Weighted Student Formula (WSF) Project Financial Plan.
- Provides data elements/queries, analyses, and recommendations to the Committee on Weights (COW).
- Assists schools with the coordination and implementation of the financial portion of the Academic/Financial Plan for schools, and the Indexed Complex Area Allocation for complex areas.

## PROCUREMENT AND CONTRACTS BRANCH

The Procurement and Contracts Branch services all schools and offices by (1) performing periodic reviews of procurement practices; (2) providing assistance, advice, guidance, and training in matters relating to procurement and contracting; (3) developing and revising procurement and contracting policies and procedures; (4) preparing and formalizing bid specifications, solicitations, and contract documentation for specific goods, services, and construction as requested by schools/offices and/or for select commonly-used departmental commodities or services; and (5) issuing formal solicitations and awards in compliance with applicable laws and regulations.

### Procurement and Contracts Section

The Procurement and Contracts Section's responsibilities include:

- Maintains thorough knowledge of current laws, rules, policies, regulations and procedures governing the department's centralized procurement and contracting activities; studies laws, rules, regulations, and policies as they affect procurement and contracting procedures.
- Develops bidding procedures and contract methods for routine to the most complex, specialized and technical projects; studies the impact of the program on outside activities or the effect of changes of outside activities on the program (e.g., changes in commodity prices, business practices, shipping strikes, etc.).
- Prepares specifications, terms and conditions to meet the minimum requirements of the user while assuring maximum competition based on the purchaser's needs; determines whether bids meet specifications and legal requirements; and develops specifications for the establishment of new price lists.
- Prepares procurement notices; tabulates and summarizes bid results, analyzes and evaluates offers to determine the most advantageous offer, recommends awards, and issues award upon purchaser's approval.
- Prepares resultant contracts in accordance with state and federal laws, rules and regulations and with program objectives and requirements; prepares any price list addenda or renewals; prepares contract modifications and/or terminations according to applicable laws, rules and policies.
- Reviews for sufficiency the justification and statutory compliance for sole

source, emergency, exempt or restrictive purchases and recommends such action when appropriate.

- Assists in the identification of problems or concerns with the terms and conditions of the contract; recommends additional terms and conditions after careful consideration of the issues in consultation with the Purchaser; gathers information for/from vendors and provides clarification to questions/concerns regarding the execution of the contract; reviews certificates of compliance.
- Reviews contracts for compliance with applicable policies, rules, regulations and laws and provides technical assistance to program staff in the development, management, and execution of contracts.
- Problem-solves a wide range of complaints which could not be resolved at lower levels regarding procedures, policies, product quality, contract performance, late payments, unfair or biased actions.

#### Procurement Assistance, Compliance, and Training (PACT) Section

The Procurement Assistance, Compliance, and Training (PACT) Section is responsible for the following:

- Serves as technical resource to the Chief Procurement Officer, administrators, and bidders to ensure compliance with the Procurement Code, applicable state and federal administrative rules and regulations applicable to purchasing mandates and guidelines, other policies or procedures governing state agencies and organizations, and departmental policies or procedures.
- Conducts periodic reviews of departmental procurement practices, including recommending appropriate revisions to procurement policies and procedures.
- Assists in conducting fact-finding investigations and making recommendations in the event vendors fail to perform according to the contract term and conditions; and investigates inquiries, complaints or controversies from department purchasers and/or vendors or contractors; reports findings of facts and may recommend appropriate or corrective action or refer the case to the Department of the Attorney General, as appropriate.
- Conducts periodic audits of school and offices in all areas of procurement and contracting to evaluate compliance with the Procurement Code and departmental policies and procedures, including the preparation of reports and briefing of senior management officials on the findings and recommendations to correct procurement and contracting deficiencies or refer the case to the Department of the Attorney General, as appropriate.
- Assists schools and offices in developing and implementing corrective actions in response to audit compliance issues.

#### HAWAII CHILD NUTRITION PROGRAMS

- Develops and administers the USDA Food Nutrition Programs which receive funds and commodities from the USDA grants for the State of Hawaii.
- Serves as the State Agency (SA) and primary contact with the USDA for all issues concerning the administration and operation of all Food Nutrition Programs in Hawaii.
- Administers and oversees the following USDA Food Nutrition Programs:

- National School Lunch Program
  - School Breakfast Program
  - Child and Adult Care Food Program
  - Commodity Distribution Program
  - Summer Food Service Program
  - Special Milk Program
- Provides program marketing and advocacy initiatives, technical assistance, and oversight for all USDA Food Nutrition Programs.
  - Prepares budgets, expenditure plans, and financial reports and projections for the SA.
  - Reviews SA federal grant reports and monitors for compliance with federal program requirements.
  - Provides technical assistance in developing and administering fiscal policies and procedures.
  - Orders, allocates, and distributes commodities.
  - Coordinates with the USDA to provide food for disaster relief for the State of Hawaii.

#### HEALTH CARE CONTRACTS AND REIMBURSEMENT PROGRAM

- Administers the Medicaid Reimbursement Program.
- Develops, implements, and evaluates reimbursement regulations, methodologies, and rates for health care services, supplies, and equipment.
- Develops, procures, monitors, and reviews contracts with individual health care providers, institutions, and fiscal agents.
- Manages and coordinates the use of the Medicaid information system.
- Manages and monitors the Third Party Liability recovery program and other claims.

#### 6. OFFICE OF TALENT MANAGEMENT

The Office of Talent Management (OTM) administers a comprehensive personnel program for certificated, classified, and casual employees of the public school system within the framework of established laws, policies, and accepted principles of personnel management. OTM develops and administers administrative rules and regulations; publishes operational guidelines; and provides centralized employment and personnel administration services to schools, district and state administrative offices to ensure that the support is being provided efficiently and effectively. The scope of the comprehensive personnel program includes the following services:

- Recruitment, selection, and employment processing
- Teacher Reclassification
- Certification of educational officers
- Leave administration
- School administrator training
- Employee awards and recognition
- Criminal history record checks
- Temporary Disability Insurance Program administration
- Collective bargaining and negotiations
- Labor Relations and contract administration

- Administration of employee benefit programs
- Classification and compensation systems
- Employee development and training
- Performance Management systems
- Workers' Compensation Program administration
- Leadership development

Under the direction of the OTM Assistant Superintendent and directors, these services are provided directly, or coordinated throughout the public school system, by the following organizational groups: Recruitment Section; Classification and Compensation Section; Employee Records and Transactions Section; Personnel Regional Officers; Labor Relations Section; Negotiations Section; Investigation Section; Civil Rights and Compliance Branch; Workers' Compensation, and Employee Benefits Section; Performance Management Section; Training and Development Section; Management Support Services Section; and Leadership Institute, including the Professional Development and Educational Research Institute and Teacher Induction Center.

#### ASSISTANT SUPERINTENDENT'S OFFICE

The Assistant Superintendent provides direct supervision over the Labor Relations Section, Investigations Section, Negotiations Section and Leadership Institute Branch.

##### Labor Relations Section

- Administers the employee grievance/arbitration program, which includes processing employee/union grievances; provides advisory services and coordination of grievance hearings at the various levels; serves as the DOE advocate in grievance and arbitration cases; maintains a system of grievance recordkeeping and accountability; and conducts workshops for first-line supervisors and middle-management personnel on the processing of employee grievances and contract administration.
- Plans and administers the contract administration, compliance and monitoring program for the public school system.
- Serves as liaison between the public school system and various unions on employer-employee matters as required by state statutes and/or collective bargaining agreements.
- Provides guidance in the processing of employee disciplinary actions, non-renewal of employee contracts and termination of employment for disciplinary reasons, maintaining a system of recordkeeping and accountability for adverse disciplinary actions; and conducts workshops for first-line supervisors and middle-management personnel in the processing of adverse disciplinary actions.
- Fosters and maintains positive and cooperative working relationships with the unions.
- Coordinates Release Time requests for bargaining unit representation by the Hawaii Government Employees Association, Hawaii State Teachers Association, and the United Public Workers.
- Assists and advises as required regarding investigations and fact-finding related to allegations of employee misconduct.

##### Investigations Section

- Provides investigative services concerning workplace complaints to include, but not limited to, complaints that may be highly sensitive in

nature, complex and difficult, involve allegations of wrongdoing or violations of policy and ethics, and employee misconduct.

- Responsible for policies, guidance and training related to employee investigations.

#### Negotiations Section

- Provides research, technical information, staff support, and facilitation assistance to the negotiations teams and spokespersons for teachers and educational officers; may also serve as spokesperson.
- Provides research, technical information, and staff support to the negotiations teams for the classified bargaining units (Units 1, 2, 3, 4, 9, 10, and 13).
- Assesses the effectiveness of operations and procedures in relation to future negotiations.
- Coordinates the preparation of the initial intent and new contract language interpretation for teachers and educational officers.
- Provides staff assistance and maintains records and files on collective bargaining and negotiations, as mandated by the legislature or negotiated agreements, such as Labor Management Cooperation Committee, Grievance Protocol Committee, and Labor Relations Committee.
- Maintains liaison between the Board of Education (BOE) and other state agencies in collective bargaining and negotiations matters, e.g., assisting in coordinating the preparation of memoranda of understanding necessary to implement new provisions of negotiated agreements; and assisting other state agencies on collective bargaining matters relating to collective bargaining units and employees.
- Advises the BOE members serving on the respective School Community Councils (SSC) Exception Review Committees for Bargaining Unit 5 and Bargaining Unit 6 on issues relating to requests for contract exceptions.
- Coordinates, monitors, and maintains the Consult and Confer process and all communication to the Unions as part of that process.
- Maintains the School Code/Standard Practices on personnel policies, regulations and procedures as provided for by the BOE and state statutes, which include recommending revision to conform to provisions of negotiated contracts to the BOE and providing interpretations of approved School Code/Standard Practices provisions.

#### Leadership Institute Branch

The branch provides direct supervision over the Professional Development and Educational Research Institute (PDERI) and the Teacher Induction Center (TIC)

#### Professional Development and Educational Research Institute (PDERI)

- Responsible for program leadership and coordination of all activities related to professional development of school administrators and educational officers.
- Researches and shares information regarding best practices related to instruction and school leadership.
- Provides coordination necessary to develop and implement an integrated professional development program.
- Supports teacher leaders and administrators with overall leadership development, mentoring and support.

- Designs and conducts the training sessions for the Teacher Leader Academy, Cohort Program, Hawaii Principals Academy, and Superintendent's Academy.
- Conducts and participates in focus groups and forums related to leadership.
- Plans, develops, conducts, and administers the school administration training program for the screening, training, and certification of school administrators.
- Develops partnerships with the universities in support of administrator training.

#### Teacher Induction Center

- Reviews and revises the State Induction Program Standards
- Monitors and assists complex areas in implementing, improving, and sustaining their teacher induction plans
- Facilitates induction networks among complex areas to build induction leadership capacity
- Identifies, trains, and supports effective instructional mentors to sustain high quality induction programs

#### Civil Rights Compliance Branch

The Civil Rights Compliance Branch promotes equal opportunity in educational programs and activities, equal employment opportunity, and equal access to Department of Education programs, services, and activities in compliance with various federal and state civil rights laws.

- Coordinates and promotes the public school system's equal employment opportunity program as it relates to non-discrimination on the basis of race, color, sex, religion, national origin, ancestry, age, physical or mental disability, sexual orientation, marital status, arrest and court record, income assignment for child support, National Guard absence, uniformed services, breastfeeding, and citizenship status.
- Coordinates and promotes the public school system's equal education program as it relates to non-discrimination on the protected basis, including but not limited to race, color, national origin, sex, religion, or disability.
- Coordinates and promotes the public school system's equal access program as it relates to non-discrimination on the basis of disability.
  - Publishes equal opportunity notices and information materials for dissemination to the public, students, parents/legal guardians, and/or employees.
  - Provides training to school personnel, students, parents and other groups on civil rights compliance matters.
  - Develops equal employment and equal educational opportunity policies for adoption by the Superintendent of Education and the Board of Education.
  - Responds to inquiries concerning the civil rights of students, employees, and the public; provides advice and assistance to school

officials and program managers regarding compliance with federal and state civil rights statutes and regulations.

- Coordinates the department's response to compliance reviews and complaint investigations conducted by federal and state civil rights enforcement agencies such as the U.S. Equal Employment Opportunity Commission, U.S. Department of Education's Office for Civil Rights, U.S. Department of Justice, and the Hawaii Civil Rights Commission.
- Conducts investigations of alleged civil rights violations in the public school system and/or supplements investigations conducted by school officials and program managers.

The remaining groups are divided into three branches with each branch headed by a director, who is responsible for the operation and supervision of each group in the branch.

The Personnel Management Branch includes the Recruitment and Employment Section; Classification and Compensation Section; and Records and Transactions Section.

The Personnel Assistance Branch includes the Workers' Compensation (WC) and Employee Benefits Section; and Offices of the Personnel Regional Officers.

The Personnel Development Branch includes the Training and Employee Development Section; Management Support Services Section; Educator Quality Section; Performance Management Section and Educator Effectiveness System Section.

## PERSONNEL MANAGEMENT BRANCH

The Personnel Management Branch administers the recruitment process for the filling of vacant positions; processing of personnel actions for qualified applicants selected to fill position vacancies, as well as personnel actions for existing employees; and classification and compensation system for all positions.

### Recruitment and Employment Section

- Plans and administers a recruitment program for all employees in the public school system: identifying and publicizing actual and anticipated vacancies; screens and refers, qualified applicants for vacancies through applicant lists; provides guidance and procedures for interview and selection; processes selected applicants for employment; and responds to related inquiries.
- Administers the Educational Officer Recruitment Program which includes but is not limited to identifying and publicizing actual and anticipated vacancies (principals/vice-principals, 12-month internal and external); administers the recruitment of non-DOE prospective school level administrative applicants – coordinates, screens, and refers applicants; coordinates interview and selection guidelines and responds to educational officer recruitment inquiries.
- Ensures that educational officer selection criteria, procedures, and compensation practices comply with federal and state laws, the School Code, and the bargaining contract, where applicable.

- Upon approval by the superintendent, processes the filling of temporary appointees to vacant educational officer positions and the filling of substitutes (retirees) to school-level educational officer vacancies.
- Maintains and monitors web page used to market school personnel for DOE positions.
- Plans and coordinates the teacher assignment and transfer program for employees in the public school system.
- Administers Teacher Reclassification Program.
- Maintains database of external administrators who possess the required qualifications as determined by the DOE.
- Administers, plans, develops, and coordinates the Part-Time Temporary (PTT) Teacher Program which includes the Casual Personnel System.
- Reviews and verifies all athletic coach jobs in the Casual Personnel System.
- Administers, plans, develops, and coordinates the teacher's Job Sharing Program, Early Return Program, and Hardship Transfer Program.
- Determines initial classification for substitute teacher applicants and reclassification of existing substitute teachers.
- Reviews and verifies all summer school hires on the Casual Personnel System.
- Maintains database for DOE Driver Education Certification and issues DOE Driver Training and Education Instructor Certificates.
- Maintains and trains a cadre of qualified interviewers to conduct interviews for all teacher applicants.
- Administers the Recruitment and Retention Program to provide qualified teachers and support staff.
- Ensures contract provisions of recruitment agency's contracts regarding scope of services are appropriately monitored; ensures budget and allocation amounts are adequate for funding needs; revises contracts as necessary to clarify procedural requirements and/or changes in scope of services and compensation; ensures contract funds are appropriately spent; works toward building capacity for DOE to assume contracts responsibilities when contracts are terminated.
- Tracks and documents all implementation steps necessary to meet state benchmarks for activities relating to personnel recruitment.
- Administers and processes the hard-to-fill incentive for qualified special education teachers and regular education teachers in identified hard-to-fill schools.
- Administers and processes the incentive program for the return of qualified teachers who have dual certification to special education.
- Administers and processes the reimbursements and annual differential incentive for the National Board for Professional Teaching Standards (NBPTS) program.
- Provides and monitors the relocation bonus for qualified teachers who are recruited from the continental United States that meet the criteria as determined by the DOE.
- Provides linkers to the Hawaii Teacher Standards Board for concerns related to teacher licensing.
- Coordinates job searches and placement for the Return to Work Priority Program.



### Employee Background Check Unit

- Processes criminal history record checks and clearances for all employees, prospective employees and others as required.
- Coordinates exchange of highly confidential information with federal and state criminal and investigative agencies when processing classified information on individuals subject to criminal history record checks and clearances.
- Maintains a confidential, highly classified database on background information on all employees of the DOE.
- Responsible for suitability procedures, practices, analyses, determinations and appeals.

### Classification and Compensation Section

- Administers, implements, monitors, and evaluates the establishment, reallocation, and deletion of all DOE positions. Develops and maintains a DOE position management system through an electronic database system.
- Analyzes DOE's classification problems and issues; develops program and operational procedures and practices for all DOE positions; conducts DOE classification studies and special projects; and conducts on-site desk audit reviews, as needed.
- Maintains a compensation plan consisting of all classes of work in the classification plan, indicating class titles and appropriate salary schedules in coordination with other jurisdictions.
- Conducts reviews to determine if labor shortages exist for classes of work or group of positions. Monitors statewide labor market conditions and participates in wage surveys. Establishes a raised hiring rate or authorizes hiring above the minimum salary when a labor shortage is identified in order to better compete in the recruitment and fill of positions.
- Provides management advisory services to DOE offices, district/complexes, line managers, and others; develops classification procedures and guidelines; provides technical assistance to others in their use and application.
- Maintains position descriptions for all existing positions and classification specifications, except for teachers and teacher-type positions.
- Conducts annual reviews of projected school lists to ensure all positions are properly identified and assigns position numbers for new positions for the upcoming school year.
- Under Weighted Student Formula (WSF) in accordance with each school's Academic Financial Plan (AFP), establishes/deletes positions beginning in May through February of the new school year.
- Recommends the development of new and amended class specifications, including minimum qualification requirements; analyzes the scheme of classes for program improvement.
- Recommends bargaining unit designations.
- Represents the DOE in civil service classification appeals to the Merit Appeals Board (MAB).
- Maintains and establishes occupational group codes for all DOE positions.

- Conducts annual review of the principal and vice principal classification levels to ensure positions are properly classified.
- Supports the Classification/Compensation Appeals Board to review classification and compensation actions relating to educational officers.

#### Employee Records and Transactions Section

- Administers the salary and compensation of all employees; certifies pay authorizations; and ensures that employees are paid properly.
- Processes all personnel actions from initial appointment to separation for employees during their employment with the DOE.
- Provides employment information and reports to comply with requirements of federal, state programs; provides employment verification; provides employee information as requested in accordance with State Office of Information Practices guidelines.
- Develops guidelines and procedures to ensure that personnel transactions are processed in accordance with applicable personnel rules and regulations, collective bargaining provisions, and departmental regulations and procedures.
- Provides technical guidance, support, and assistance to departmental administrators, supervisors, managers, and staff regarding personnel transactions matters.
- Provides technical support and assistance for ensuring compliance with federal laws such as the Fair Labor Standards Act, the Immigration Reform and Control Act and leave laws.
- Plans and administers an employee records program. Maintains employee information in the DOE's computerized personnel systems and maintains salaried employees' official personnel folder (OPF).
- Administers the DOE Leave Sharing Program.
- Administers the Sabbatical and Professional Improvement (PI) Leave Programs
- Administers the Unemployment Insurance (UI) Program. Provides unemployment verification.

#### Substitutes Unit

- Administers the Substitute Teacher Program.
- Administers the salary and compensation of substitute teachers.
- Processes all personnel actions from initial appointment to separation for employees during their employment with the DOE.
- Provides substitute teacher employment information and reports to comply with requirements of federal and state programs; provides employment verification for substitute teachers; provides substitute teacher employee information as requested in accordance with State Office of Information Practices guidelines.
- Develops substitute teacher guidelines and procedures to ensure that personnel transactions are processed in accordance with applicable personnel rules and regulations, and departmental regulations and procedures.
- Provides technical guidance, support, and assistance to departmental administrators, supervisors, managers, and staff regarding substitute teacher personnel transaction matters.

- Maintains substitute teacher information in the substitute teacher's computerized systems and maintains substitute teacher's official personnel folder (OPF).

## PERSONNEL ASSISTANCE BRANCH

The Personnel Assistance Branch is comprised of the following sections/functional areas, with its respective functions: WC, and Employee Benefits Section, which administers workers' compensation benefits, health benefit plans, other employee benefits (e.g. tax-sheltered annuities, liaisons to provide benefit information, etc.) and temporary disability insurance program administration; and the Offices of the Personnel Regional Officers, which provides direct personnel services to the assigned areas/offices.

### WC, Employee Benefits Section

#### Workers' Compensation (WC) Unit

- Plans and administers the WC Program for all employees, and students and adult volunteers that are providing services to the DOE.
- Determines eligibility for WC benefits.
- Processes WC claims and pays for WC benefits as required by WC law.
- Monitors WC activities for effectiveness and efficiency.
- Represents the DOE at Department of Labor and Industrial Relations (DLIR) – Disability Compensation Division hearings.
- Provides staff support to the staff of the Department of the Attorney General on matters relating to appeals at the DLIR – Labor Appeals Board and third-party liability claims.
- Assists with returning claimants back to work as soon as possible and refers claimants to the Return-to-Work Priority Program.
- Ensures compliance with applicable WC laws, related administrative rules, and DOE policies and procedures.
- Plans and administers certain bloodborne pathogens activities for the DOE as follows:
  - Provides and coordinates Hepatitis B vaccinations for all qualified DOE employees.
  - Provides access to bloodborne pathogens training information involving universal precautions.
  - Processes and pays for medical costs related to post-exposure evaluation and follow-up for DOE employees who are exposed to bloodborne pathogens while performing work-related tasks.

#### Employee Benefits Unit

- Assists with the administering of health benefits plans offered by the Hawaii Employer-Union Health Benefits Trust Fund (EUTF).
- Administers the Tax Shelter Annuity 403(b) Program for eligible employees in the DOE.
- Liaison between the DOE and other State agencies (ERS, EUTF, DHRD, etc.) to provide information and updates to all employees related to the State's Deferred Compensation Program (DC 001), PTS Deferred Compensation Retirement Plan (DC 015), Island Flex Flexible Spending Accounts Program, Premium Conversion Plan, EUTF plans and the ERS program.

- Works with the Payroll Section to provide information and updates on the DOE's Post-Separation Vacation Pay Deferral Program.
- Processes temporary disability insurance claims for all employees of the DOE.

The Offices of the Personnel Regional Officers provide employment and personnel administration services to schools, complexes, districts and state offices, within the framework of established laws, policies and accepted principles of personnel management. The scope of the services provided by the Offices of the Personnel Regional Officers includes:

- Recruitment, selection, and employment processing
- Certification of teachers and educational officers
- Leave administration
- Personnel resource accounting and position allocation
- Interpretation and implementation of personnel policies and procedures
- Training of school administrators
- Employee awards and recognition
- Criminal history checks
- Employee grievances
- Conduct investigations and provide advisement
- Teacher induction and mentoring programs
- Onsite personnel liaison to the complex area and assistant superintendent(s)
- Contract implementation and interpretation
- Employee benefits
- Classification and compensation
- Fair labor practices
- Employee evaluation system
- Substitute employees and casual hires

The Offices of the Personnel Regional Officers foster and maintain positive working relationships between the DOE, unions, and other agencies.

#### PERSONNEL DEVELOPMENT BRANCH

The Personnel Development Branch coordinates training and development opportunities for classified employees; administers the employee evaluation program; teacher and school administrator effectiveness systems; employee awards; compliance and monitoring of federal and state requirements for Every Student Succeeds Act for Supporting Effective Instruction (ESSA); maintenance and updates of the departmental organizational charts and functional statements; review of proposed reorganizations; legislation coordination, budget/fiscal oversight, and procurement contracts for OTM; manages incentive program for special education teacher certification; development and maintenance of various human resources systems to support personnel decision making; tracking of OTM performance measures; and administers Title IIA, Hawaii qualified teacher program.

#### Training and Development Section

The Section collaborates with program managers and supervisors to identify needs of employees in order to provide training and development opportunities.

The Section also administers the Para-Educator Training Program consisting of coursework and classroom observations focusing on instructional practices in support of classroom teachers. In addition, the Section reviews requests from preparation programs for the placement and supervision of practicing professionals in DOE schools.

- Establishes and manages policies, processes and procedures for employees to participate in professional development opportunities.
- Collaborates with program managers, supervisors and other stakeholders regarding employee professional development opportunities based on evaluation data, professional standards and other job performance indicators.
- Develops and maintains new employee orientation program
- Provides access to professional development resources that meet the needs of classified employees.
- Tracks professional development participation.
- Collaborates with Performance Management to identify areas for improved data analysis for targeted professional development.
- Coordinates Preparation Program Field Placement.
  - Manages policies, processes and procedures for programs requesting candidate placement.
  - Collaborates with other DOE offices and Hawaii Teacher Standards Board (HTSB) in review of program requests.
  - Communicates with programs to clarify placement requirements, policies, and/or notice of non-authorization to place candidates in DOE schools.
  - Notifies programs of eligibility status of formal agreement with the DOE including agreement renewal.
  - Communicates with schools as needed regarding candidate placement.
  - Collaborates with DOE offices and programs in the revision of formal agreements, policies, or the approval process as required.
  - Collaborates with Teacher Recruitment regarding placement information including candidate suitability as required.
- Administers Para Educator Training Program.

Para Educator Training Program – this program provides comprehensive, systematic, competency-based training to educational assistants (EA) and other support service personnel to increase their knowledge and skills to improve their performance in the classroom. The training includes in-service workshops to schools, professional development courses, and career ladder opportunities.

- Designs, develops and implements training programs for paraprofessionals.
- Develops and writes Instructional Modules for EA orientation, immediate and advanced courses.
- Develops, writes and implements in-service and workshop modules for complex waiver days and other school requests which address specific issues faced by paraprofessionals.
- Designs and develops formative and summative evaluation plans for paraprofessional training.
- Observes and assesses classroom performance.
- Prepares bi-monthly newsletter for distribution to all paraprofessionals.

- Creates, copies and distributes flyers, posters, memos regarding professional development opportunities.

#### Management Support Services Section

- Reviews, analyzes, and recommends reorganization proposals based on sound organization principles and in compliance with the governor's administrative directive.
- Publishes and maintains the DOE's official Plan of Organization; coordinates the annual update.
- Serves as liaison between the DOE and agencies to ensure correct and proper communication in the implementation of compliance activities.
- Assists the branch with coordination of legislative bills.
- Provides budget and fiscal oversight for OTM.
- Monitors OTM performance measures.
- Assists the branch with compliance to procurement requirements.
- Provides data collection, analyses, and reporting.
- Administers Special Education Teacher Incentive Program
  - Collaborates with preparation program and participant on stipend eligibility criteria, roles and responsibilities, fund distribution, timelines, and DOE formal agreements.
  - Establishes communication process with preparation program for updated participant eligibility lists, dissemination and collection of participant signed agreement, participants' program completion status, and data required by DOE and preparation program for reporting requirements.
  - Participates with preparation program in orientation meetings to present incentive opportunities and obligations to potential participants as appropriate.
  - Accesses HRMS database to track and document participants' employment obligation status.
  - Notifies participants and preparation program of non-compliance with program and/or DOE employment obligation and implements process for the collection of funds owed the DOE.
  - Communicates with the Attorney General's Office (AG) as required for outstanding cases.
  - Maintains annual record and account status of funds used for incentive including enrollment data, obligated completers, withdraws, etc.

#### Educator Quality Section

- Builds a system of capacity within each Complex Area to support non-Hawaii qualified teachers.
- Provides training for Principals on Hawaii qualified teacher requirements.
- Prepares and conducts statewide Teacher Outreach.
- Supports, educates, and advises non-Hawaii qualified teachers to become qualified.
- Reviews all new teacher records to determine Hawaii qualified status for Title IIA of the ESSA.
- Monitors the status of all non-Hawaii qualified teachers.

- Administers Title IIA funds.

#### Performance Management Section

- Develops and implements a worker performance system that links evaluations, timely and appropriate prescriptive professional development, and incentives to support quality workers.
- Develops and maintains the profiles or standards for teachers and administrators.
- Manages DOE awards and recognition programs.

#### Educator Effectiveness System Section

- Develops and maintains educator effectiveness system of performance evaluation for teachers and school administrators.
- Supports implementation of educator effectiveness system by providing technical assistance and coordinating state-led training.
- Coordinates efforts across state offices to ensure quality implementation of evaluation and support systems.

### 7. OFFICE OF INFORMATION TECHNOLOGY SERVICES

The Office of Information Technology Services (OITS) administers and manages information and telecommunication systems, facilities, and services of the public school system in order to support the department's mission of improving student achievement. OITS ensures that information technology and telecommunications support are provided efficiently and effectively, and in accordance with state laws, policies, and management principles.

The scope of OITS includes voice, data, video, information technology infrastructure, and support services for schools, complex areas, and state administrative offices. OITS provides the public school system with leadership and support in the management and use of information, telecommunications, instructional technologies and related resources; develops strategic plans, policies, procedures, and standards for information and telecommunication services; plans, implements, and maintains the information and telecommunication systems infrastructure, local and wide area networking, and statewide connectivity to provide training and technical support in use of voice, video, data, and information systems; and provides direct consultative services to schools through the assignment of staff to school sites.

Under the direction of the Assistant Superintendent, OITS, these functions are organized into six (6) branches:

- School Technology Support Branch (STSB)
- Enterprise Systems Branch (ESB)
- Enterprise Infrastructure Services Branch (EISB)
- Information Technology Project Management Branch (ITPMB)
- Enterprise Architecture Branch (EAB)
- School Process and Analysis Branch (SPAB)

#### SCHOOL TECHNOLOGY SUPPORT BRANCH (STSB)

The School Technology Support Branch (STSB) is dedicated to improving the quality and responsiveness of information technology services and support to the

schools, complex areas, and state administrative offices. The STSB is responsible for establishing and managing service level agreements with internal Department of Education (DOE) customers.

The STSB is organized into two sections:

Complex Area IT Managers Section (CAITMS): Dedicated to serve a specific complex area, this section is responsible for providing localized technical support and collecting user feedback to better serve the users of DOE applications at the school and complex area levels.

- Provides consultative design services to schools and offices to meet their customized functional needs.
- Provides Tier 3 onsite user support in access and use of the telecommunication network, networked computer resources and applications.
- Supports the schools in effective use and application of standard statewide computer applications
- Researches, reviews, analyzes, and assesses emerging telecommunications technologies and services for possible applications and practices to improve instructional and administrative functions and improve student performances. Informs and advises schools of possible use of these technologies to achieve their instructional and administrative objectives.
- Evaluates telecommunications hardware, software, and services for possible school applications.
- Evaluates effectiveness of the technology and telecommunication network implementation and use in the functional areas, and makes recommendations for improvements.
- Develops and proposes budget requirements for future network projects according to school-identified priorities and technology plans. Assists schools in the selection and purchase of equipment and software necessary to implement and maintain their technology projects.
- Perform other duties as assigned.

IT Information and Support Section (ITISS): Responsible for planning, coordinating, administering, and implementing a department-wide support, information, and service desk program on information technology systems and services to continually develop the knowledge and skills of administrators, professional and technical staff, and clerical personnel to efficiently and effectively use department-wide information technology systems. This section is comprised of (3) units:

IT Information and Support Unit I (ITISU I):

- Responsible for administration and support of the ITSM tool and phone system for the IT Help Desk, management and maintenance of Information Technology Centers.
- Provides system administration and support for the Information Technology Service Management (ITSM) tool used to track IT help



desk requests submitted by Department administrators, faculty, and staff. Work with vendor to plan upgrades, organize testing of releases, troubleshoot tech issues, slow response times, browser compatibility etc.

- Provides system administration and support for the Call Manager (phone) system and integration with the ITSM tool.
- Manages desktop systems and technology for ITISS staff and in Information Technology Centers (ITCs) located on Oahu, Kauai, Maui and the Big Island.
- Provides/arranges training sessions for ITISU III support staff on technology topics in order to support Department customers.
- Assists with IT process improvements and supports operations of ITSM tool.
- Perform other duties as assigned.

#### IT Information and Support Unit II: (ITISU II):

- Responsible for establishing and improving IT support processes.
- Define and document IT support process flows in collaboration with IT and related support staff.
- In collaboration with appropriate personnel (IT staff, SMEs, business analysts, etc.), create new and/or improved processes based on best practices and user feedback to improve efficiency among support staff and meet customer service requirements of Department end users.
- Work with IT and related support staff to implement updated processes and ensure continuous process improvements.
- Work with ITSM system administrator and Help Desk support staff to ensure processes are reflected in implementation and operation of ITSM tool.
- Provides/arranges training sessions for ITISU III support staff on technology topics in order to support Department customers.
- DPSA: Perform backup ITSM and phone system administration support.
- Perform other duties as assigned.

#### IT Information and Support Unit III: (ITISU III):

- Responsible for first line of support to troubleshoot IT access and technical issues, communicate information related to IT services, and provide online resources on effective use of supported IT services.
- Provide an intake and escalation point for IT-related issues and tracking of these issues using IT Service Management (ITSM) tool.
- Refer users to appropriate areas of support.

- Assist users with password resets and login issues.
- Provide support and user assistance on DOE supported email system.
- Convey information on the status of the DOE's network and enterprise systems (i.e., what is up/down).
- Convey information on IT updates and alerts such as end-of-life for browsers, OS, etc.
- Convey information related to security awareness (e.g., guidance on protecting passwords, phishing alerts, etc.).
- Develop an online "one stop shop" for the above information, as well as "getting started" and "guide to services" information
- In consultation with schools and offices, assesses education needs, and develops online documentation and resources to develop knowledge and skills in the use of supported IT systems and technologies for administrative and educational operations.
- Provides/arranges training sessions for ITISU III support staff on technology topics in order to support Department customers.
- DPSA: Perform backup ITSM and phone system administration support.
- Assists with IT process improvements and supports operations of ITSM tool.
- Perform other duties as assigned.

Customer Service Desk Unit (CSDU): Responsible for the first line of support to enable access and troubleshoot functional and technical issues related to the department's applications, telecommunications, and technical infrastructure.

- Provides a centralized "one stop" service desk for users to call for fault, configuration, accounting, performance, security, use, or issues with any OITS supported system Manages the Lotus Notes electronic mail statewide system, including user-level and organizational-level security certificates, mail accounts, and web access.
- Assist in testing user functionality for enrollment/curriculum systems (eSIS, eCSSS; Future applications will may include IIS).
- Perform other duties as assigned.

#### ENTERPRISE SYSTEMS BRANCH (ESB)

The Enterprise Systems Branch (ESB) consolidates into one branch the responsibility for designing, developing, implementing, and supporting the core student information, operational applications, and enterprise resource planning (ERP) of the public school system. The scope of ESB includes the

design, development, and implementation of requested enhancements to existing DOE applications, as well as investigating and resolving application issues or deficiencies. The ESB is organized into four (4) sections with an Enterprise Resource Planning System Office coordinating the ERP functions:

Web Applications Development Section (WADS): Responsible for the department's SharePoint, Lotus Notes database applications and other various custom built web based application development and support.

- Plans, designs, develops and implements system-wide functional enhancements to the department's Web and SharePoint applications based on business requirements.
- Provides design and overall direction to the technical staff on the programming of enhancements or new uses for Web and SharePoint software.
- Provides Lotus Notes applications development and support for existing State and School Level applications.
- Coordinates efforts to ensure the department's web sites comply with the Americans with Disabilities Act directives and Children Internet Protection Act.
- Participates in planning, designing, and implementing of the department's Internet and Intranet Web and SharePoint application plans.
- Applies web-services technologies to create web-based computer applications and associated data bases for financial and other administrative needs.
- Provides maintenance and level III user support of Web and SharePoint applications.
- Performs other duties as assigned.

Instructional Improvement Systems Section (IISS): Responsible for the department's core student applications for learning management, case management, and student information management. Core student applications in scope include, but are not limited to, DSI, eCSSS, eSIS and the future Instructional Improvement System which consolidates the functions of these systems.

- Assists the development, maintenance and adherence to policies and procedures, standards, and guidelines to ensure quality processing, communication, and dissemination of student information and data.
- Provides technical consultation in planning and developing new or enhanced student information systems in order to ensure long-term compatibility and usability of information and data.
- Provides support for the development, maintenance, and support for core student applications.

- Assists in the planning, requirements gathering, design, implementation, testing and operations of new core student applications or enhancements of existing ones.
- Provide input on technical and strategic decision making for the department when requested.
- Performs other duties as assigned.

Facilities IT Services Section (FITSS): Responsible for the providing IT support services to the Office of Facilities and Operations (OFO) for operations and upgrades to various Facility IT systems.

- System Analysis, Planning, Project Management.
- Systems Procurement services.
- Enterprise Software licensing support.
- Enterprise System Analytical and Programming Support -Web Design/Update, Lotus Notes database.
- Electronic Leave System (ELS) – Software provisioning, user support, administration, maintenance.
- Performs other duties as assigned.

Data Management Section (DMS): Responsible for department's data warehouses and reporting applications, including the K-12 Longitudinal Data System (LDS). This section provides requirements definition, system design, development, maintenance, operation, and support of decision support applications and associated integrated databases. These applications transform and integrate data from the department's operational data systems into an integrated data structure optimized for on-line analysis. They also provide associated user tools to summarize or drill-down, aggregate or disaggregate, and produce results in either tabular or graphic forms, referred to as "business intelligence."

- Develops and maintains the department's data management strategy.
- Assists with system and database management, system analysis, analysis of hardware and software alternatives, and programming support for the development and installation of new application systems for information processing.
- Assists with enhancement and maintenance support for existing statewide application systems to meet user requirements and implement new or revised system software and hardware.
- Assists with planning and designing the databases for statewide school application systems.
- Provides assistance in the preparation of technical specifications for bids and contracts relating to DOE database architecture and standards, and participates in the selection process.

- Designs and implements data integration between internal and external DOE applications using Extract, Transform and Load (ETL) as well as Enterprise Application Integration (EAI) such as SQL Server Integration Services (SSIS) and Microsoft BizTalk.
- Performs other duties as assigned.

The Enterprise Resource Planning Systems Office (ERPSO) is responsible for DOE support of the statewide Financial Management System (FMS), time and attendance, budgeting and human resources applications. This office will also provide DOE support for the Statewide Implementation of an Enterprise Resource Planning System.

FMS Section (FMSS): Responsible for the design, development, enhancement, maintenance, and support of FMS.

- Provides systems development, enhancement, and maintenance support for the client-level software which runs on the FMS workstation at each school and office, and provides the user interface to the department's financial management systems.
- Plans and designs the databases for application systems.
- Provides systems development, enhancement, and maintenance support for the department's primary financial systems which includes purchase order processing, payment processing, fixed assets, general ledger, cash receipts, and other accounting functions residing on a mainframe computer.
- Provides enhancement and support of the local school fund accounting system which is used by all schools to keep records of non-appropriated funds.
- Develops technical user manuals required to utilize, operate, enhance, and maintain these computer-based application systems. Also provides technical assistance in user training on new application systems.
- Plans and designs the databases for application systems.
- Manages the financial system DB2 database structure and program libraries, and performs database administration (DBA) functions that include daily monitoring of all database relations to detect and correct conditions that may otherwise lead to database corruption or decrease performance.
- Performs technical evaluation and testing of new hardware and software tools to facilitate the enhancement of the department-wide financial management systems.
- Performs other duties as assigned.

Time and Attendance Systems Staff (TASS): Responsible for the Time and Attendance (Tm&Att) System planning, design, implementation and Tier 3 support to all schools and offices statewide. In addition, TASS in collaboration with the School Technology Support Branch provides Tier 3

support and assistance in troubleshooting as well as assist in the development of training materials.

- Provides application maintenance of the production and testing environment within the Time and Attendance (Tm&Att) System.
- Performs software testing on the Tm&Att System.
- Assists the Office of Fiscal Services to define functional, nonfunctional and technical requirements regarding Leave Accounting and Time and Attendance and translate them into technical and functional specifications.
- Resolves Tier 3 Tm&Att system problems/errors.
- Assists the ISTU in the development of Time and Attendance system user manuals for distribution to all schools and offices.
- Develops programming documentation to operate, enhance, and maintain these systems.
- Performs other duties as assigned.

Budget Systems Section (BSS): Responsible for the design, development, enhancement, maintenance, and support of the budget system.

- Provides systems development, enhancement, and maintenance support for the department's Budget Preparation and Budget Execution systems: Budget System, Allocation Notices, Carryover, Mass-Load of Adjustments and Interfaces, Financial Plans, WSF and ICAA Buy/Sell, eHR reference tables, modifications to the Financial Data Warehouse, Budget Preparation System, Salary Projection, Biennium & Supplemental Adjustments, Biennium Request & Review Forms, Biennium Book, and Budget Prep Reports.
- Provides system and database management, system analysis, hardware and software alternatives analysis, and programming support for the development and enhancement of new budget system requirements: Casual Payroll System, OTM Reports, and Facility Inventory System,
- Provides enhancement and maintenance support for statewide budget application systems to meet the budget director's and budget analysts' requirements, and also requirements from the legislature and the Budget and Accounting Office's requirements: Monthly Financial Reports that integrate data from Budget System and FMS, HUEY Data Warehouse, Financial Data Warehouse (Versifit), Financial Reporting System's SharePoint site, Financial ODS and reports.
- Develops documentation required to use, operate, and maintain these computer-based application systems and provides technical assistance in user training.
- Plans and designs the database for application systems. Performs database administration (DBA) functions that include regular monitoring of database activity to detect and correct conditions that may lead to database corruption or decreased performance.

- Provides technical support in resolving software problems.
- Assist in the technical evaluation and testing of new hardware and software tools to facilitate the development and enhancement of the department's Budget systems
- Performs other duties as assigned.

Human Resources Application Section (HRAS): Responsible for the design, development, enhancement, maintenance and support of the DOE's human resources and payroll pre-processing computer system applications.

- Provides systems development, enhancement, maintenance and support for the position management, employee recruitment/job referral, employee background check/review, employee job assignment, employee salary classification/qualification, employee personnel action, employee payroll payment transaction, tax shelter annuity payroll deduction transaction, statutory due payroll deduction transaction, teacher leave transaction, employee professional development and employee worker's compensation functions on e-HR servers, PDE3 servers, VAX Alpha, TSEAS VIP server, Worker's Compensation Renaissance server and ICSD's IBM mainframe.
- Manages the VAX Oracle RDB Personnel/Payroll and Time & Attendance database structures and program libraries, and performs database administration (DBA) functions that include daily monitoring of database activity to detect and correct conditions that may lead to database corruption or decrease performance.
- Provides systems development, enhancement, maintenance and support for the DAGS Salaried Payroll Change Schedule Employee Transactions, DAGS Non-Salaried Employee Payroll Time Card Transactions, DAGS Payroll Register Employee Transactions, DAGS Employee W-2 Transactions, DAGS Payroll Employee W-2 Address Transactions, DAGS Payroll Employee Tax Exemptions/Marital Status File, DHRD Workforce Employee Files, ERS Employee Personnel Action Transactions, ERS Participants File, B&F Labor Negotiation Employees File, DAGS Employee EEOC Occupations File, DAGS Overtime Employee Transactions File, ING Deferred Compensation Employees File, NBS DAGS Payroll Tax Shelter Annuity Employee Deduction Transactions, DAGS Payroll NBS Employee Tax Shelter Annuity Payroll Deductions Dispersement File, MBC Teachers/Course Subjects Being Taught File, UPW Employees File and HGEA Employees & Positions Files external DOE file transfer interfaces as well as internal DOE file transfer interfaces with the FMS, Budget and Time & Attendance Computer Systems.
- Provides technical support in resolving software problems
- Assists in the technical evaluation and testing of new hardware and software tools to facilitate the development and enhancement of personnel and payroll pre-processing computer application systems.
- Performs other duties as assigned.

## ENTERPRISE INFRASTRUCTURE SERVICES BRANCH (EISB)

The Enterprise Infrastructure Services Branch (EISB) is responsible for the planning, design, construction, and support of the department's statewide telecommunications network architecture and infrastructure. The EISB manages and administers access to the department's applications and provides the infrastructure to support employee workstations across the public school system. The EISB is organized into two (2) sections with two (2) support offices:

### Enterprise Network Design Section (ENDS):

- Plans, coordinates, and schedules with the Information and Communication Systems Division (ICSD) of the state Department of Accounting and General Services for the access and use of their computer resources and services.
- Provides engineering, planning, installing and operating of the WAN that connects the school networks to the global network through WAN technologies.
- Determines requirements for WAN to support information technology infrastructure including data, image, and video communication systems in coordination with other state agencies, other offices in the department, and the schools.
- Plans and manages performance of Internet backbone access network through the commercial network service provider and manages network access to Internet II through the University of Hawaii.
- Plans and coordinates with other state agencies to implement and expand/upgrade the statewide backbone network, such as the state's institutional network (I-Net) to support data, video, and voice communication requirements for the department. Manages and operates the department's part of the I-Net to provide high capacity network connections.
- Evaluates WAN telecommunications hardware, software, and services. Develops specifications for competitive bidding and participates in evaluation of bids and selection of appropriate vendors and network transport service providers.
- Researches, analyzes, and assesses the applicability of the advances in WAN telecommunication technologies and services to stay abreast of major trends and potential applications for improving the department's WAN.
- Performs other duties as assigned.

### Construction Design Section (CDS):

- This section plans, designs, installs, maintains, and repairs the physical telecommunication network for voice, video, and data in schools and district/state offices.



- Supports schools in planning, designing, upgrading, and installing voice, video, and data networks in accordance with the school technology plans and/or to address specific requirements (e.g., safety/security, special student needs, etc.).
- Plans, schedules, designs, and installs the school physical network infrastructure in accordance with school technology plans, industry/building standards, and department standards and requirements.
- Supports schools in participating in programs and applying for funds for school telecommunication network installation, operation, network enhancements, and upgrades. Processes program applications on behalf of schools (e.g., E-Rate Program).
- Participates in project planning (initial planning, review/revision), progress monitoring, and final inspections of telecommunication-related Capital Improvement Projects (CIP) for the schools.
- Perform other duties as assigned.

Enterprise Network Support Office (ENSO): This office is responsible for the planning, designing, installing, maintaining, and repairing the enterprise network that includes voice, data, video and physical plant infrastructure for schools, complexes, and state offices. ENSO is comprised of two (2) sections:

Enterprise Network Support Section (ENSS): Responsible for planning, designing, installing, and maintaining the network technologies that provide connectivity for the public school system.

- Plans and implements disaster recovery plans in cooperation with the other state agencies and department's offices.
- Plans, installs, and manages the network and computer access and security servers such as firewall server, intrusion detection server, Internet filtering server, anti-virus server, Internet cache server, load balancing server, etc. Monitors the network access for security, and coordinates security management with other sections/units in the branch and other offices in the division.
- Analyzes usage and performance data to monitor and optimize the capacity and effectiveness of the department's host and distributed computer systems and plans for their expansion.
- Works with services/system providers and end users in the resolution of problems involving the department's network and computer systems.
- Monitors the operation of the department's wide area data network (WAN) and the local area data networks participating in the department's WAN. Coordinates activities to correct any WAN malfunctions.
- Manages installation and upgrade of the departments WAN for data, and video for remote school/office sites and central communications

center sites in accordance with school technology requirements, industry standards, and department's plans/requirements.

- Manages daily operations of the WAN for data and video, manages telecommunication network services provided by telecommunications service providers and WAN hardware/software vendors.
- Schedules and monitors the operations of statewide data, image, and video communication systems to optimize the use of available telecommunication resources. Monitors network performance of the WAN through the network management systems and takes appropriate action to provide network capacity required by various applications for the schools and offices.
- Manages Internet resources such as IP addresses, autonomous system number for the department. Allocates IP addresses to schools and offices. Designs, plans, and operates IP (public and private) assignment scheme to the schools and offices.
- Reviews and approves all requests for data, image, and video telecommunication network and services.
- Provides Internet and Intranet services to all department users and manages planning, installing, and operating of the various Internet server hardware and software used to provide the required services.
- Manages the department's Internet/Intranet computer resources; performs system management functions of the computer servers; manages user accounts; installs, configures, and maintains services such as E-mail, Web services, Usenet news, mailing lists, domain name services, Internet chat and others.
- Provides the security of the Internet servers; works with other Branch sections/units on planning and operations of the firewalls, intrusion detection system, web content filtering servers, anti-virus system, etc. Investigates computer security break-ins and cyber misconducts committed by the department users.
- Performs other duties as assigned.

Telecommunications Support Section (TSS): This unit plans, designs, installs, maintains, and repairs the physical telecommunications network for voice, video, and data for the schools, complex areas, and state administrative offices.

- Manages planning, installation, and operation of the voice network for the department's schools and offices.
- Provides support in planning and installing voice network infrastructure according to the school technology plan and planned administrative and instructional uses.
- Works with telecommunication service providers to secure quality and timely service at schools and offices, handles billing issues, and communicates to schools awareness of new services available to the department. Advises schools to ensure effective use of funds, credits, and reimbursements.

- Supports the schools in planning, procuring, configuring, installing, and upgrading of the voice processing systems, such as PBX and Voice over IP systems.
- Coordinates all voice-related services and equipment installation for schools through the Telecom Request process.
- Manages repair and maintenance requests by coordinating services provided by the unit and telecommunication equipment repair service providers.
- Coordinates with other state agencies in the use of the statewide voice network system and service projects and contracts.
- Installs, analyzes, and tests school and office voice network, voice system and components, determining the cause of any problem, and replaces or repairs the source of the trouble. Provides periodic preventive maintenance of voice network and equipment as needed.
- Performs other duties as assigned.

Systems Infrastructure Office (SIO): This office is responsible for operation of computer hosted and distributed servers; security access, controls, monitoring, and security architecture; disaster recovery plans and procedures; system and network performance data analysis and monitoring; and management of system resources include allocation of data storage and storage area network resources. In addition, this section will setup and distribution of standard workstation images and content to user workstations and computer devices. SIO is comprised of two (2) sections:

Systems Administration Section (SAS): Responsible for operation of computer hosted and distributed servers; security access, controls, monitoring, and security architecture; disaster recovery plans and procedures; system and network performance data analysis and monitoring; and management of system resources including allocation of data storage and storage area network resources.

- Designs, implements, and provides system administration for internal networked servers which support infrastructure for this branch's daily operations as well as other local and statewide applications.
- Manages the DOE-wide distributed server infrastructure.
- Performs system administration of all servers. Defines and implements database administration including both logical and physical file structures.
- Defines, configures, and implements server data replication and data backup policies.
- Manages operations of enterprise computer host and distributed servers for administrative and instructional uses, including servers for network access and protection, and the storage area network systems.

- Develops and implements procedures and safeguards against unauthorized access to departmental systems and networks, and manages and grants user authorization to access application systems and data.
- Installs and maintains operating system, database management, networking, and system utility software for the department's host and distributed computer systems.
- Prepares bid specifications for planned resources and acquires and installs major computer hardware and software.
- Manages system resources, including the allocation of data storage resources, storage area network resources for the department's host and distributed computer systems.
- Plans and manages the computer data backup library and the safekeeping of data files through appropriate backup systems and off-site storage.
- Performs system administration and maintenance functions for the Internet and Intranet servers. Applies all software upgrades and patches, manages new installation and upgrade of hardware and software.
- Evaluates, monitors, and analyzes performance of the Internet and Intranet servers and network connections/utilization for effective capacity planning and performance optimization.
- Performs other duties as assigned.

School Infrastructure Section (SIS): In conjunction with school technology coordinators, this unit is responsible for the setup and distribution of standard workstation images and content to user workstations and computer devices.

- Provides technical support in resolving computer hardware and software problems, as well as data communication problems.
- Provides assistance to state and district offices in setting up, configuring, and trouble-shooting of hardware and software.
- Plans, installs, and supports internetworking connections between the school local area network (LAN) and the WAN for schools' access to the Internet and the Intranet, sets up and supports Internet services such as NAT, DHCP, DNS, Network Security System, Network Management System, etc.
- Provides support in the area of installation, administration, and management of the network for schools and offices; and provides support in management and use of the networked resources effectively and efficiently.
- Provides technical consultation and support in planning, designing, implementing, and operating networked applications of the schools operating in the school LAN, across the department's WAN and Internet.

- Determines the network requirements for the school, provides support in selection and procurement of the network infrastructure that meets the requirements of planned or existing applications.
- Participates in establishing, reviewing, and updating the department's networking policies, standards, and procedures for the installation and operation of telecommunication networks for voice, video, and data. These reviews are based on the current and emerging technologies and their potential benefit of the educational objectives and administrative needs of the schools.
- Provides second level technical support to users in the schools and offices in troubleshooting problems and providing assistance with the Internet services offered. Provides support to the school technology personnel in the schools, who provide the first level of technical support.
- Sets up Internet and Intranet client applications and services for the schools and offices. Advises users with problems determination and resolution for Internet and Intranet application systems.
- Maintains and repairs school physical telecommunication network for voice, video, and data.
- Performs other duties as assigned.

#### INFORMATION TECHNOLOGY PROJECT MANAGEMENT BRANCH (ITPMB)

The Information Technology Project Management Branch (ITPMB) is responsible for managing OITS' major projects to a successful conclusion, in support of the DOE's mission and strategic goals.

- The ITPMB also manages the development and application of knowledge and skills related to project management. This function includes the development and maintenance of project management methodologies, which contain processes, procedures, templates and systems that support the planning, execution, monitoring and completion of OITS projects, and training in project management for OITS personnel.
- The ITPMB is responsible for maintaining the Department's IT lifecycle methodology and standard project management practices for information technology projects.
- The ITPMB is also responsible for the communication of overall project status related to its assigned projects to OITS leadership, and will manage the project change control process and project issue management process for OITS.
- It will work with other OITS branches in the integration of project management methodology and skills with OITS' system development life cycle.
- Assist in project selection, which will include project identification, project categorization, prioritization, selection, and project chartering.
- Responsible for project quality management, which includes quality assurance for projects, which may include project reviews, and

quality control processes to ensure acceptance of delivered products and services.

- Perform other duties as assigned.

#### ENTERPRISE ARCHITECTURE BRANCH (EAB)

The Enterprise Architecture Branch (EAB) is responsible for the development and management of the DOE's Enterprise Architecture (EA) program which consists of documented IT policies, processes, and standards. In addition, the EAB manages the enterprise architecture plan which is a living document consisting of the public school system's information and applications, and aligning that vision to the department's goals, processes, roles, organizational structure, and organizational behaviors. The EAB, in collaboration with the department's leadership, defines the relationship of the department's information and systems to external parties. The EAB provides a synthesis of the people, processes, and technology required to deliver on the mission and goals of the public school system.

- Analyzes current and future planned DOE IT systems, applications, data, and business drivers to develop current and future Enterprise Architecture (EA) requirements and structures, considering systems, data, platforms, networking, programming techniques and languages, and the external and internal environment.
- Designs and develops criteria for DOE EA requirements, to include compatible systems, applications, networking, data, and the like.
- Ensures OITS EA strategy includes a balance of business, information, technical, and solution systems focused on today's DOE business requirements, but with the capacity to emerge and grow to support future requirements.
- Analyzes IT market and technology trends, to include emerging capabilities and systems, and their possible impact on DOE requirements, to identify areas requiring future EA changes and potential emerging capabilities and their impacts on DOE.
- Develops and manages enterprise architecture governance structure based on business and IT strategies via the Technical Architecture Review Council
- Oversees EA implementation and ongoing refinement to ensure robust support of DOE and OITS strategic goals and objectives, and ensures appropriate modifications to the EA are raised and acted on through the governance structure.
- Responsible for managing the Enterprise Architecture standards database which includes enterprise, application, data, integration, infrastructure and security standards.
- Develops and executes strategic communication plan for EA within DOE.
- Reviews all OITS projects being proposed for planning, design, implementation, and is authorized to approve, reject, or require

remediation to ensure alignment with the DOE's Enterprise Architecture plan and standards.

- Provides expert advice regarding fit in the future EA, required modifications of either the project or the EA to accommodate emerging requirements.
- Perform other duties as assigned.

#### SCHOOL PROCESS AND ANALYSIS BRANCH (SPAB)

The School Process and Analysis Branch (SPAB) is responsible for the management and oversight of a consolidated center of expertise with resource teachers who can translate instructional and classroom requirements into technology solutions through business analysis processes and standards. The SPAB maintains Authorized Courses and Code Numbers (ACCN) for enrollment/curriculum systems in collaboration with the Office of Curriculum and Instructional Design (OCID) and may lead eCSSS or eSIS projects upon request. The SPAB also has responsibility for issuing and collecting federal surveys. The SPAB is organized into two (2) sections:

School Process and Analysis Section (SPAS): Responsible for interacting with school and complex area personnel to gather requirements to inform improvements to DOE applications, telecommunications, and technical infrastructure.

- Coordinates quarterly scripts.
- Coordinates Summer School conversion with schools.
- Creates, reviews, updates user documentation and user guides for enrollment/curriculum systems (eSIS, eCSSS; Future applications which may include IIS).
- High level training, e.g. registrar operations, master scheduling, school year beginning/ending registrar tasks, athletic eligibility, counselors, etc.
- Reviews and sends updates for enrollment/curriculum systems (eSIS) training videos.
- Assists as the Center of Expertise for school level issues.
- Assists in user testing for enrollment/curriculum systems (eSIS, eCSSS; and IIS in the future).
- Assists with DOE and enrollment/curriculum systems (eSIS, eCSSS) help desk calls and email as 3rd level support.
- Provides input requiring school expertise regarding Registrar/Registrar clerk type of responsibilities when requested.
- Reminds schools to check error reports and assists schools in solving data errors when requested.
- Troubleshoots discrepancies in GPA, credits, and master schedule student schedules when requested.
- Works with other offices and or other sections regarding discrepancies and movement of large numbers of students upon request (case by case)
- Develops business requirements and functional specification of core student applications

- Performs student setup changes, communicates with schools to develop customer reports in core student applications
- Assists with core student application testing
- Performs other duties as assigned by the SPAB Director

Federal Survey Section (FSS): Responsible for the planning, support, inventory, sorting, packing, checking, coding, data entry and shipping of Federal Surveys. The FSS also works with schools and military branches to correct /complete information on the federal survey cards. Perform other duties as assigned.

## 8. OFFICE OF HAWAIIAN EDUCATION

The Office of Hawaiian Education provides the resources needed to fully implement the goals and objectives of Hawaiian education to include the study of Hawaiian culture, history, and language in the public schools along with the achievement of the Hawaii Content and Performance Standards.

- Provides leadership in the development of culturally relevant educational programs which use Hawaiian culture, history, language as the foundation for the achievement of the Hawaii Content and Performance Standards.
- Assesses, analyzes, evaluates, plans and develops tools and resources to support the needs of students, complex areas, complexes, and schools in relation to the effective implementation of Hawaiian education programs such as the Hawaiian Studies Program and the Hawaiian Language Immersion Program.
- Works in partnership with Hawaiian organizations and agencies in support of the State Constitutional mandate to promote Hawaiian education within the public school system.

## 9. ADMINISTRATIVE ASSISTANT OFFICE

The administrative assistant to the Superintendent of Education provides staff support by coordinating the department's response to requests for administrative information and action from the Board of Education, legislature, other Executive Branch agencies, officials from other state and federal educational agencies, interest groups and the general public and ensuring that the department is advancing on the goals laid out in the Strategic Plan.

- Maintains control of all incoming and outgoing executive communications and records management for the Office of the Superintendent.
- Assists the Superintendent in proposing agenda items for Board meetings; assures timely availability of staff reports, study materials and resource persons from appropriate staff offices and coordinates follow-up staff action on Board requests made to the Superintendent.
- Serves as the Superintendent's liaison with the State Legislature, as directed; coordinates department staff work in response to legislative requests for information, legislative reporting, drafting and seeking introduction of legislation, monitoring the status of pending legislation, and



preparing testimony and monitoring committee hearings on proposed legislation.

- Assists the Superintendent in coordinating the department's participation in administrative programs and activities of the Executive Branch including coordination of legal issues and lawsuits.
- Responds to news media, group and public requests for information, including Chapter 92F, Uniform Information Practices Act, H.R.S., and responds to or revers inquiries to appropriate sources.
- Advises and assists the Superintendent in complying with state protocol and fulfilling obligations as a public officer in dealing with individuals and organizations representing national and international interests in public education.
- Provides other personalized administrative assistance to enable the Superintendent to carry out duties and responsibilities as the Board's executive officer for the public school system.
- Coordinates special projects in which other agencies or private organizations are involved, as assigned by the superintendent.

#### 10. INTERNAL AUDIT OFFICE

The Internal Audit Office provides independent, objective assurance and consulting services to add value and improve the DOE's operations and internal control structures. Internal Audit assists the DOE to accomplish its objectives by bringing a systematic, disciplined approach to evaluate and contribute to the effectiveness of risk management, control, and governance processes.

The Internal Audit Office's primary responsibilities include reviewing the effectiveness of the internal control structure, identifying opportunities for process and control improvements that would mitigate risk exposures, monitoring compliance with laws, regulations, policies and procedures, and sharing best practices throughout the DOE. In carrying out these primary responsibilities, the Internal Audit Office will, among others:

- Annually develop and execute a flexible audit plan using an appropriate risk-based methodology, for the evaluation of critical financial, operational and compliance processes that provide oversight and controls to the DOE.
- Review and monitor that corrective action plans, recommendations for improvement, and correction of reported deficiencies resulting from internal, external, or legislative audits, have been effectively implemented and addressed.
- Coordinate audit activities with the State Department of Accounting and General Services (DAGS) Audit Division, the Office of the Legislative Auditors, and external auditors to ensure proper coverage and minimize duplication of efforts.
- Examine the effectiveness of all levels of management in their stewardship of DOE assets and resources.
- Conduct investigations of allegations concerning DOE fund or asset misappropriations.

- Promote understanding and appreciation of internal controls and their application to the DOE's operations through written and oral, formal and informal, communications with management and the Audit Committee, where applicable.

The Internal Audit Office is independent of all other departments within the DOE, and is free from undue influence in selecting and determining the scope of activities, performing examinations, and communicating the results. The Internal Audit Director reports directly to the Superintendent of Education and the Audit Committee of the Board of Education.

**DEPARTMENT OF EDUCATION**  
**OFFICE OF THE DEPUTY SUPERINTENDENT**  
**FUNCTIONAL STATEMENT**

**DEPUTY SUPERINTENDENT OF EDUCATION**

The Deputy Superintendent assists the Superintendent of Education in executing duties and responsibilities of the office, and is delegated authority to act for the Superintendent of Education.

The Deputy Superintendent is responsible for leading, directing and supervising the academic and educator development functions of the Department of Education, as well as serving as the line officer for school operations. The Deputy Superintendent also directly manages projects or issues that are of special significance to the Department's mission or Strategic Plan.

This position oversees the Department's 15 Complex Areas, the Monitoring and Compliance Branch, and the Coordinated Support Office.

The following branches and offices report directly to the Deputy Superintendent.

**1. COMPLEX AREA SUPERINTENDENTS**

Public schools are assigned, for administrative purposes, to complex areas of one or more school complexes, each consisting of a high school and its feeder middle and elementary schools. There are fifteen (15) complex areas in the statewide public school system. Each complex area is supervised by a complex area superintendent who reports directly to the Deputy Superintendent. The complex area superintendent assists individual schools and school complexes in meeting the Hawaii Content and Performance Standards, Hawaii Goals for Education, and the education renewal initiatives of the state and federal government. Complex area superintendents exercise supervision over school renewal specialists and other educational support personnel and monitor the provision of centralized fiscal, personnel, and facilities support by other DOE state offices to facilitate school renewal efforts.

**Complex Area Superintendent**

- Supervises schools in a complex area and provides area-wide program coordination and support of special education, special services, and federal-funded programs.
- Provides area-wide program coordination and support of special education, special services, school-based mental health and federal-funded programs.
- School-Based Support Services: Occupational and Physical Therapy Program
  - Administers the Occupational and Physical Therapy Program (OT/PT)
  - Coordinates with the schools to identify health problems and occupational and/or physical therapy needs as related to the students' educational programs in the district. Assures appropriate resources to the schools to provide occupational and/or physical therapy services to support the educational program of identified students.

- Consults with school personnel, families and others to assure that there is integration of educationally related OT/PT strategies into the school curriculum and home.
  - Collects appropriate data to assure compliance of timelines and that eligible students are receiving the necessary occupational and/or physical therapy services.
  - Collaborates and coordinates with the state office to assure that there is conformance with program standards and established procedural guidelines.
  - Coordinates with the state office for orientation of new occupational and/or physical therapists.
  - Coordinates with the schools to assure appropriate office space for the therapy staff within the district.
- Reviews each school's strategic and academic/financial plans for, and progress towards, attaining effective school status.
  - Provides consultation and professional assistance to schools and complexes to ensure sound planning, effective implementation, and efficient use of available school resources for curriculum, instruction, and student services reform aspects of school renewal.
  - Facilitates, monitors, and assesses the effectiveness and responsiveness of fiscal, facilities, personnel, information and telecommunications, and other administrative support services that are centrally administered by DOE state offices and other state agencies; maintains liaison between schools and the central services agencies to assure that services meet current operational and projected school renewal requirements.
  - Coordinates schools' requests for assignment of school renewal specialists from Office of Curriculum and Instructional Design and/or Office of Student Support Services or from other complex areas or complexes to assist a particular school or complex in its restructuring efforts; exercises field supervision over school renewal specialists who are assigned to assist the schools and complexes.
  - Promotes collaboration among schools in each complex to articulate their educational programs and student performance expectations, coordinate school renewal and improvement efforts, and share resources.
  - Coordinates sharing of resources among complexes in the area, and cooperative support arrangements between complex areas.
  - Develops and maintains collaborative partnerships with the University of Hawaii and other institutions of higher learning to support school renewal efforts of the complex area schools.
  - Maintains liaison with government, community, and business organizations and officials on matters of mutual interest involving the complex area's schools. Conducts meetings and hearings to ensure administrative due process for students and employees of the complex area in accordance with law and department rules and regulations.

## Schools

Public schools assigned to the complex areas include elementary, intermediate and middle schools, high schools, special schools for qualified students with disabilities, and institutionalized juvenile delinquents, offering instruction in grades K-12; and community schools for adults.

## Complex Learning Support Centers

Complex learning support centers facilitate sharing of curriculum and instructional resources among schools of a school complex, which consists of a high school and its feeder elementary and intermediate or middle schools. The complex learning support centers provide technical support to schools in the complex. In addition, there is much collaboration between and among support centers.

## 2. MONITORING AND COMPLIANCE BRANCH

The Monitoring and Compliance Branch evaluates the department's compliance with federal laws, U.S. Department of Education requirements, and Board of Education administrative rules and policies related to the implementation of on-going federally funded programs.

This office implements differentiated monitoring of state offices based upon a compliance assessment, which includes a review of implementation fidelity at the Complex Areas and where applicable, the Public Charter School Commission.

The Monitoring and Compliance Branch serves as the primary contact with federal program officials regarding the state educational agency responsibilities outlined in these on-going federally funded programs.

The office provides technical assistance on grant compliance to department staff.

The Monitoring and Compliance Branch is responsible for the Dispute Resolution Procedures required under the Individuals with Disabilities Act and Chapter 60, HAR, and the complaints processes applicable under the Elementary and Secondary Education Act, as amended.

## 3. COORDINATED SUPPORT OFFICE

This small, nimble team, led by the Deputy Superintendent's executive assistant/chief of staff, provides staff support to the Deputy Superintendent to increase his/her capacity to successfully perform critical daily functions; manage high-level special projects and coordinate cross-functional efforts across offices.